

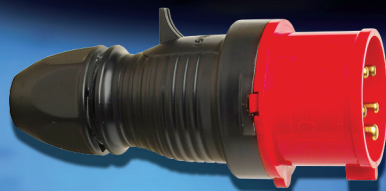

Walther
Electrotechnical Systems

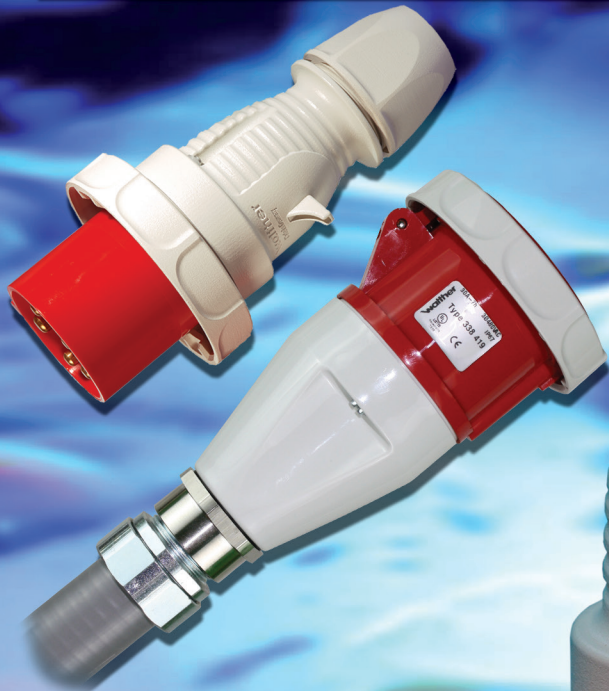

IEC 60309-1 & 2 Pin and Sleeve Devices



Walther

Electrotechnical Systems



Walther Electric is an international company that is committed to outstanding service and providing electrical interconnect products and power distribution systems to customers & industries around the world. Walther Corporate Headquarters is located in Eisenberg, Germany with full service subsidiaries in The United States, The United Kingdom, France and Austria. Our “Global Team” is made up of highly respected and industry qualified representative agents in more than 70 countries.

Established in 1897 - and from the very beginning Walther has been known for its progressive engineering and innovative product designs and manufacturing capabilities. All Walther products are designed and manufactured to not only meet but to exceed industry requirements for greater safety and customer performance demand.

Walther Electric’s innovative and technical product portfolio includes IEC 60309 Pin & Sleeve interconnect devices, Procon “Heavy Duty” rectangular connectors, power distribution units and systems, motor disconnect and switched safety devices, “e-Mobility” electric vehicle charging interconnect devices and charging stations.

At our North American Headquarters located in Somerset, New Jersey we are proud of our “Engineering and Technical Team” coupled with a talented inside support staff that is always ready to assist you “Our Customer” in the design/specification process and in the manufacturing of “YOUR” power distribution or control system requirements.





When you are in need of quality electrical interconnects, power distribution systems, and industry knowledgeable service, call Walther Electric, **“WE ARE”** your complete solution provider.

TABLE OF CONTENTS

IEC-309-1 and IEC-309-2 Pin and Sleeve Devices

	Introduction	2-5
	Material Specifications	6-7
	North American Ratings (20 to 100 Amp)	8-16
	Accessories	17-18
	International Ratings (16 to 125 Amp)	19-28
	New Products	29-31
	Light & Stage	32-33
	Specialty Products	34
	Portable Power Distribution	35
	Walther's Part.No..System.	36
	Useful Tables	37
	Drawings and Dimensions	38-47

IEC-309-1 and IEC-309-2 Mechanical Interlocks

	Introduction	48-49
	North American Ratings (20 to 100 Amp)	51-55
	International Ratings (16 to 125 Amp)	56-60
	Ask Walther	61

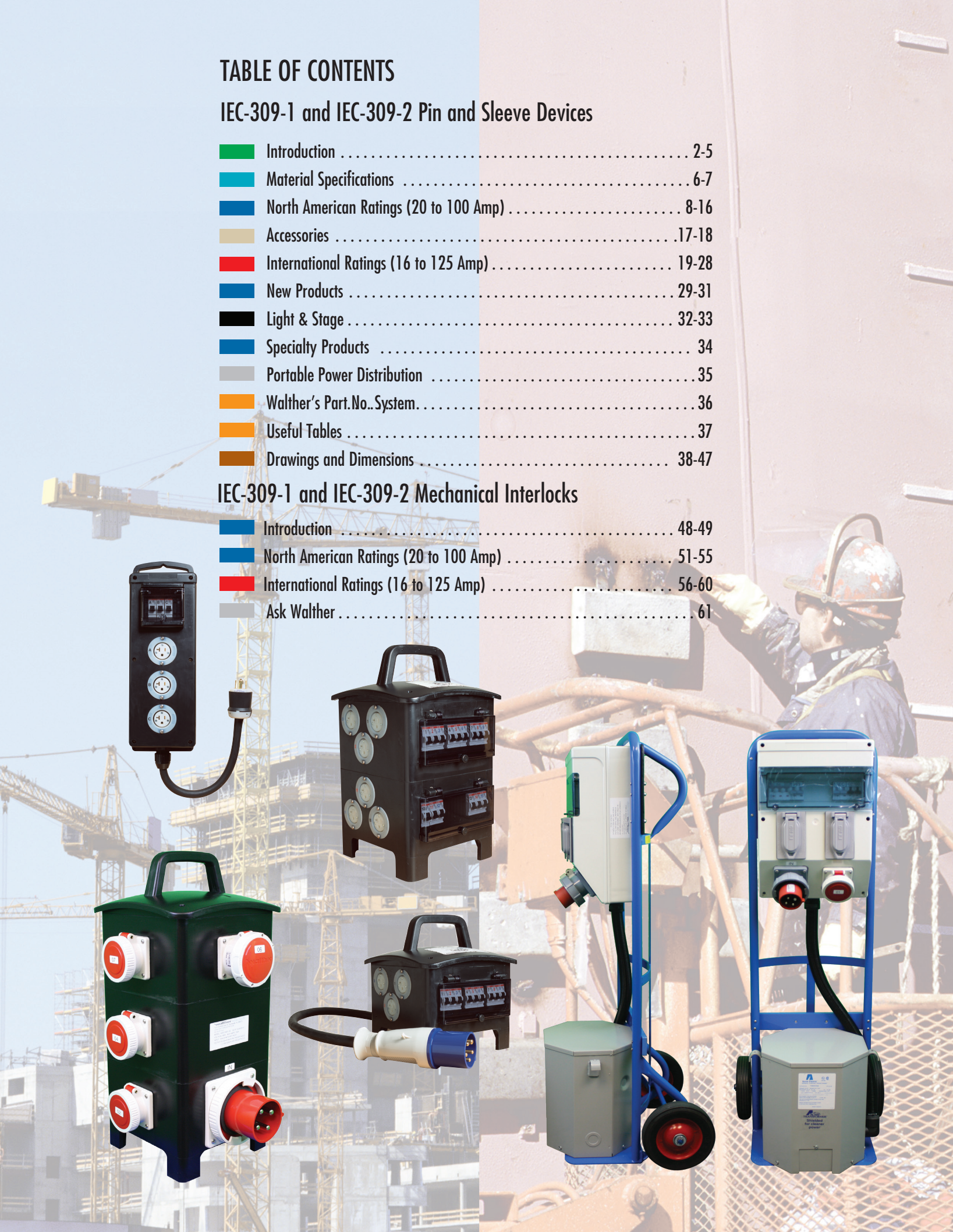

WORLDWIDE INTERCHANGEABILITY

Walther's pin & sleeve devices are built to IEC60309-1 and 309-2 specifications and are interchangeable with other manufacturers who conform to these IEC standards and color coding system... anywhere in the world. Manufacturers that do not comply with these standards have their own proprietary configurations and are not plug compatible with other pin & sleeve products. Once you have selected a proprietary configuration you are locked in to a single source. Specifying IEC60309-1 & 309-2 devices provides convenience and flexibility that users have come to accept almost without thinking.

SAFETY

IEC60309-2 configurations for plugs (or inlets) and receptacles (or connectors) are single-rated which assures proper mating of devices with the same voltage and amperage. It is virtually impossible to couple a plug and receptacle of different voltage and /or amperage ratings.

The size of the device is determined by the amperage rating. Plugs and receptacles of different amperage ratings are not compatible because of the size variance.

Many proprietary pin & sleeve configurations, that do not conform to the IEC standards, are designed to accommodate multiple voltage systems. A plug wired to a piece of equipment designed to operate at one voltage system could unintentionally be plugged into a receptacle wired with an unlike voltage. Mismatching voltages could cause damage to the equipment or even personal injury and is not considered safe electrical practice.

The voltage, of single rated Pin & Sleeve devices of the IEC 309-2 type, is determined by the location of the oversized female ground contact relative to the key-way located at the bottom of the housing. A clock face is used to represent the location of the ground sleeve for a specific voltage system. For example, a 480 VAC receptacle will have the oversized ground sleeve located in the 7 o'clock position. The corresponding grounding pin location on the plug or inlet is a mirror image of the female device. Devices of mismatched voltage systems simply cannot be mated. Each device is clearly marked with the voltage system for which it is intended to be used. The diagram below shows the keying position and the color coding that is associated with each voltage system.

Walther CEEtyp Female Ground Clockface Positions in Accordance with IEC60309-2 and UL 1686

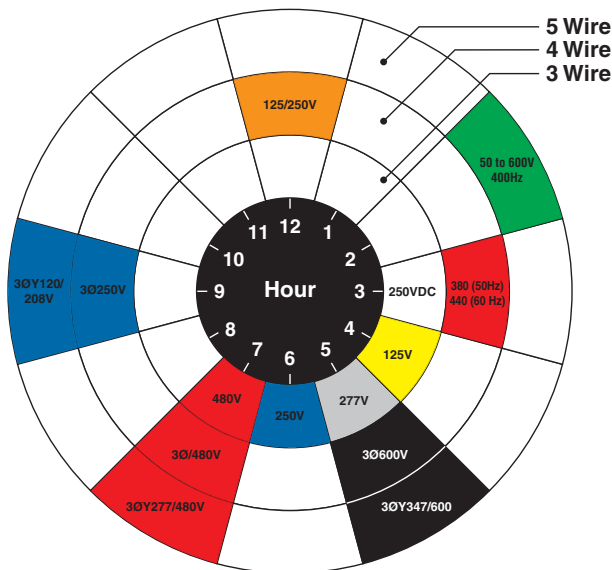

North American Rating
Voltage AC (Except where noted)

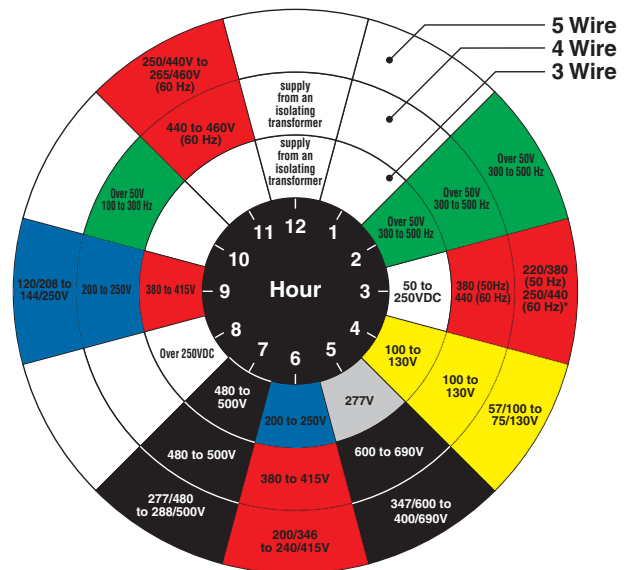

International Rating
Voltage AC (Except where noted)

The insulated housing is made from a high impact, nylon material. The nonmetallic device, while abuse and corrosion resistant, is also nonconductive, which enhances the safety of the product.

ELECTRICAL INTERLOCK

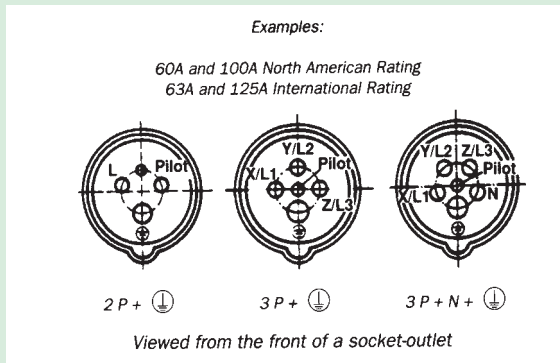

Plugs and receptacles rated 60 amps and above, feature an “electrical interlock” by way of a pilot pin on the plug and female sleeve on the receptacle that is shorter than the main pins. The pilot pin and female sleeve make contact last, and break contact first. This sequence turns the power on when the pilot pin and sleeve mate, and turns the power off before the phase contacts are disengaged. This prevents making or breaking the circuit under load.

RELIABILITY

Walther offers the widest variety of plugs, receptacles, connectors and inlets, made of the highest quality and design integrity in both splashproof and watertight versions.

Watertight (IP67) devices are designed for use in the most demanding environments that require safety, ease of use, reliability and durability. These devices can withstand impact and vibration and provide complete protection against dirt, dust, water jets and even temporary flooding. Watertight devices are available in 20, 30, 60 and 100 amp (North American) ratings and 16, 32, 63 and 125 amp (International) ratings.

Splashproof (IP44) devices are suitable and recommended for use in a variety of light industrial environments and provide complete protection against contact with live parts, damaging

deposits of dirt and dust and splashing water. Splashproof devices provide many of the heavy duty construction features found in the watertight products, but at a more economical cost. Splashproof devices are available in 20, 30 and 60 amp (North American) ratings and 16, 32 and 63 amp (International) ratings.

Watertight and splashproof devices provide exceptional UV stability for superior outdoor performance.

All Walther plugs and connectors are supplied with an internal cord clamp designed to firmly grip not only the outer cable jacket but also the internal conductors. The internal cord clamp eliminates strain on the terminals while providing high pull-out values without external protrusions to snag adjacent wiring or the installer.

In addition to the internal cord clamp, Watertight plugs and connectors are also supplied with an external cable gland. This cable gland serves as a secondary method of eliminating strain on the terminals and conductors while assuring watertight performance. Standard splashproof plugs and connectors are also supplied with the same external gland as the watertight devices. However, a cable sleeve, designed to speedup installation, is provided with a lower cost splashproof alternative.

All Walther plugs and connectors, furnished with either a cable gland or cable sleeve, meet the cord and cable secureness requirements defined in UL 1682, Section 33.

TABLE 1 - CHARACTERISTICS DEFINED BY THE CEI 70-1 - IEC 529 - IEC 144 - UTE C 20-010 - DIN 40050 STANDARDS

First Digit - Protection against persons - touching and ingress of solid foreign objects			Second Digit - Protection against the penetration of liquids								
			IP_0	IP_1	IP_2	IP_3	IP_4	IP_5	IP_6	IP_7	IP_8
Non protected											
				☐	☐	☐	☐	☐	☐	☐	☐
IP 0_		Without protection	IP 00								
IP 1_		Protection against touching with the hand and solid objects greater than 50mm dia.	IP 10	IP 11	IP 12						
IP 2_		Protection against touching with the finger and solid objects greater than 12mm dia.	IP 20	IP 21	IP 22	IP 23					
IP 3_		Protection against touching with tools, wires, etc. more than 2.5mm thick and solid objects greater than 2.5mm dia.	IP 30	IP 31	IP 32	IP 33	IP 34				
IP 4_		Protection against touching with tools, wires, etc. more than 1mm thick and solid objects greater than 1mm dia.	IP 40	IP 41	IP 42	IP 43	IP 44				
IP 5_		Unlimited protection against contact with live parts and damaging deposits of dust	IP 50				IP 54	IP 55			
IP 6_		Unlimited protection against contact with live parts and any penetration of dust	IP 60					IP 65	IP 66	IP 67	IP 68

In some countries a third digit (for mechanical security) is added.

TABLE 2

Designation	Intended Use and Description	Construction Requirements
3	Outdoor use primarily to provide a degree of protection against rain, sleet, windblown dust and damage from external ice formation.	Splashproof (IP44)
4	Indoor and outdoor use primarily to provide a degree of protection against windblown dust and rain, splashing water, hose-directed water and damage from external ice formation.	Watertight (IP67)
4X	Indoor and outdoor use primarily to provide a degree of protection against corrosion, windblown dust and rain, splashing water, hose-directed water and damage from external ice formation.	Watertight (IP67)
6	Indoor and outdoor use primarily to provide a degree of protection against hose-directed water, and the entry of water during occasional temporary submersion at a limited depth and damage from external ice formation.	Watertight (IP67)
12, 12K	Indoor use primarily to provide a degree of protection against circulating dust, falling dirt, and dripping non-corrosive liquids.	Splashproof (IP44)

This information is provided only as a general guide. No specific recommendation is intended. As each application may vary, testing should be conducted by the user in the intended environment.

IEC60309 PIN AND SLEEVE DEVICES

External Cable Gland with "Onion Ring" Neoprene Bushing
The compression type cable gland serves as a secondary method of eliminating strain on the terminals and conductors while assuring watertight performance. Accommodates various cable sizes. Reliability! Ease of Use!

Retaining Device
Holds the plug in position when it is in proper engagement with a connector or socket-outlet and prevents its unintentional withdraw

Internal Strain Relief with "Swing-Away" Feature
Designed to firmly grip not only the outer cable jacket but also the internal conductors. Eliminates strain on the terminals while providing high pull-out values. "Swing-Away" feature provides easy access to terminal screws. Reliability! Ease of Use!

Shrouded Pins
Pins are recessed in the nylon housing and protected from deforming due to physical abuse. Eliminates the potential hazard of touching the live contacts while the plug is partially engaged. Safety! Reliability!

Electro Zinc Plated Steel Screws
Corrosion resistant. Captive no loose parts to handle or misplace. Durability! Ease of Use!

Locking Ring and Gasket
Protects against intrusion of dirt, dust and moisture when the male and female devices are connected. Reliability!

Terminal Identification
Ground, neutral and phase terminals are clearly identified for easy recognition and ease of wiring.

Color Coded
Avoid mismatching. Prevents confusion with regards to voltage ratings. Safety! Ease of Use!

Spring Loaded Gasketed Covers
Protects against accidental encounter with live contacts. Also, protects against intrusion of dirt, dust and moisture. A bayonet coupling device is used to provide optimum stability an simplify installation. Reliability! Safety!

High Impact Thermoplastic Housing
The nonmetallic device, while abuse and corrosion resistant, is also nonconductive, which enhances the safety of the product. The insulated housing is made from a high impact, nylon material and is UV stabilized. Safety! Durability

Staggered Contacts
Oversized ground contact is farthest forward, assuring first make and last break. Neutral is next to prevent the possibility of an "open neutral" condition. Phase contact is farthest making it last to make, first to break. Safety!

Recessed Contacts
Contact sleeves are recessed in the narrow contact tubes thus, providing a "finger proof" device and protecting against any accidental encounter with live contacts. Safety!

Retaining Device
Walther pin & sleeve devices are provided with a mechanical arrangement which holds a plug or connector in position when it is in proper engagement, and prevents its unintentional withdraw.

Double Terminal Screws
Maximum clamping pressure without damaging strands. Double terminal screws create a large area of safe and secure contact between conductor and terminal. Screws are captive, easily accessible and supplied in the open position. Reliability! Safety!

Solid Brass Pins
Low contact resistance and high conductivity. Long lasting, reliable electrical contact. Reliability!

Split Contact Sleeve with Nickel Plated Steel Springs
Provides optimum insertion/withdraw force and constant contact pressure Reliability!

Chamfered Terminals
Funnel Entry. Guides and captures all wire strands. Ease of Use! Reliability!

PLUG

Assembly Screws*	Steel, Electro Zinc Plated
Friction Ring*	Steel, Electro Zinc Plated
Gland Cap	Polycarbonate Blend
Grommet	Solid Neoprene
Housing (Front and Back)	Type 6 Nylon
Internal Cord Clamp	Type 6 Nylon
Locking Ring	Type 6 Nylon
Pins (Watertight)	Brass, Nickel Plated
Pins (Splashproof)	Brass
Sealing Gasket	Neoprene
Terminal Screws	Steel, Nickel Plated

INLET

Housing	Type 6 Nylon
Locking Ring	Type 6 Nylon
Mounting Flange	Type 6 Nylon
Pins (Watertight)	Brass, Nickel Plated
Pins (Splashproof)	Brass
Sealing Gasket	Neoprene
Terminal Screws	Steel, Nickel Plated

* Stainless steel available upon request

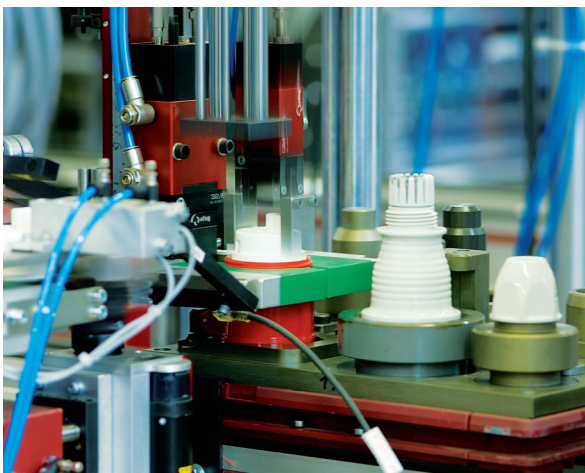
**CONNECTOR**

Assembly Screws*	Steel, Electro Zinc Plated
Cover	Type 6 Nylon
Cover Fastener	Nickel Plated Brass, Brass or Macrolon
Cover Spring	Stainless Steel (A2)
Friction Ring*	Steel, Electro Zinc Plated
Gland Cap	Polycarbonate Blend
Grommet	Solid Neoprene
Housing (Front and Back)	Type 6 Nylon
Internal Cord Clamp	Type 6 Nylon
Sealing Gasket	Neoprene
Sleeve Spring	Steel, Nickel Plated
Sleeves (Watertight)	Brass, Nickel Plated
Sleeves (Splashproof)	Brass
Terminal Screws	Steel, Nickel Plated

RECEPTACLE

Cover	Type 6 Nylon
Cover Fastener	Nickel Plated Brass, Brass or Macrolon
Cover Spring	Stainless Steel (A2)
Housing	Type 6 Nylon
Mounting Flange	Type 6 Nylon
Sealing Gasket	Neoprene
Sleeve Spring	Steel, Nickel Plated
Sleeves (Watertight)	Brass, Nickel Plated
Sleeves (Splashproof)	Brass
Terminal Screws	Steel, Nickel Plated

Manufacturing pin & sleeve devices, of superior quality, can only be accomplished through the use of high grade materials. That is an important part of the Walther Pin & Sleeve system — quality products you can depend on.

Male pins and female sleeves are made of high conductivity brass. Contacts used with watertight devices are nickel plated to prevent corrosion. The insulated housing is made from a high impact, nylon material. The nonmetallic device, while resistant to most solvents, chemicals and salt water, is also non-conductive, which enhances the safety of the product.

All extracts from manufacturing, test standard or independent agency approvals is for informational purposes only and are not intended to be, should not be used as, nor considered to be a complete description of such. Contact customer service for a more complete version of the test standard or agency approval in question.

Walther reserves the right to make technical descriptive and dimensional changes due to product changes and/or improvements.

Minimum test requirements

ELECTRICAL

Insulation Resistance	500V for 1 min. Resistance $\geq 5M \Omega$
Dielectric Voltage Withstand	3000V for 1 min.
Ground Path Current	See Table 1
Endurance, Connect and Disconnect Cycles	See Table 2
Current Interrupting	Certified for current interrupting at full rated current and voltage.
Overload Test (Power factor 0.75 - 0.80)	Tested for current interrupting at 150% of the rated current and 100% of the rated voltage for 50 cycles.
Temperature Rise	Maximum 30° C rise at full rated current (after overload).
Resistance to Arcing	Continuation of overload test for an additional 200 cycles.

MECHANICAL

Mold Stress Relief	70°C (158°F) for 7 hours.
Humidity	32°C (89.6°F), 93% humidity for 7 days (168 hours).
Cable Secureness	See Table 3
Impact	A device is wired with a 90" (2300mm) length of flexible cord and dropped from 30" (760mm) 8 times. The device is then conditioned for 6 hours at -25°C and immediately subjected to a repeated impact test.
Crushing	250 lbs for 1 minute. The device is then conditioned for 6 hours at -25°C and immediately subjected to a repeated crushing test.
Withdrawal Force	See Table 4
Strength of Insulating Base and Support	110% of specified tightening torque on terminal screws.
Polarization Integrity	Matching devices will not mate so that the ground is energized, even when polarization feature is removed and 40 lb (180 N) insertion force is applied.

ENVIRONMENTAL

Flammability	V-2 or better per UL 94 or CSA 22.2 No. 0.6
Ambient Temperature Range	Minimum: -25°C (-13°F) with impact Maximum: 90°C (194°F)
Resistance to Corrosion	Ferrous parts immersed for 10 min. in a 10% solution of ammonium chloride at a temperature of 20°C.
Moisture Resistance	Watertight (IP67): Device immersed for 24 hours in water at a temp. of 25°C, the highest point of the device being 2" (5cm) below the water level. Splashproof (IP44): Device is sprayed with water for 10 minutes and immediately afterwards subjected to splashing water in all directions (360°).
UV Resistance	Exposed plastic materials are UV stabilized.

TABLE 1

Ground Path Current Test				
Device Rating Amperes	Minimum Size Grounding Conductor		Time, Seconds	Test Current, Amperes
	AWG	mm ²		
20	12	3.3	4	470
30	10	5.3	4	750
60	10	5.3	4	750
100	8	8.4	4	1180

A test current that far exceeds the device rating, is passed through the mating devices and grounding wires.

TABLE 2

Endurance Test			
Device Rating Amperes	Cycles with Load at Rated Current and Voltage	No-Load Cycles	Sequence
20	5000	0	-
30	1000	1000	Alternating
60	1000	1000	Alternating
100	250	250	Alternating

The test sequence is conducted by using a no-load, followed by a load sequence. The power factor of the load is 0.75 to 0.80.

TABLE 3

Cable Secureness Test						
Device Rating Amperes	Force		Torque		Maximum Displacement	
	lb.	N	ft-lb.	N•m	Inches	mm
20	30	133	0.4	0.54	3/32	2.38
30	75	333	0.5	0.68	3/32	2.38
60	150	667	1.0	1.4	3/32	2.38
100	150	667	2.0	2.7	3/32	2.38

The flexible cord or cable is simultaneously twisted and pulled. Values for the applied twisting torque and force of pull are shown in Table 3. In all cases the cord displacement is less than 3/32 inches.

TABLE 4

Withdrawal Forces Test			
Device Rating Amperes	Minimum Withdrawal Force		
	lb.	N	Time, Minutes
20	5	22	1
30	6	27	1
60	15	67	1
100	20	89	1

The pressure exerted by mating contacts of a plug and connector must be sufficient to prevent unintentional withdrawal during normal use. During the test, any locking rings or retaining means are not to be engaged.







These products are Listed to applicable UL Standards and requirements by Underwriters Laboratories Inc. UL 1682 UL 1686







MALE PLUGS

UL LISTED SF Certified

			WATERTIGHT (IP67)	SPLASHPROOF (IP44)			
				Standard Version (with cable gland)	Economical Version (with cable sleeve)	Low Profile Angled 90°	
	Poles and Wires	Voltage AC (Except where noted)	Clock Position of Ground Contact				
3	2P + G	250 DC	3	219315	211315	210315	216315
	1P + N + G	125	4	219316	211316	210316	216316
	2P + G	250	6	219306	211306	210306	216306
	1P + N + G	277	5	219317	211317	210317	216317
	2P + G	480	7	219319	211319	210319	216319
4	2P + N + G	125/250	12	218424	212424	210424	216424
	3P + G	3Ø250	9	218409	212409	210409	216409
	3P + G	3Ø480	7	218419	212419	210419	216419
	3P + G	3Ø600	5	218405	212405	210405	216405
5	3P + N + G	Barge Overflow	1	218501BL			
	3P + N + G	3ØY120/208	9	218509	212509	210509	216509
	3P + N + G	3ØY277/480	7	218519	212519	210519	216519
	3P + N + G	3ØY347/600	5	218505	212505	210505	216505
7	6P + G	250	9		212709	210709	
	6P + G	480	7		212719	210719	

FEMALE CONNECTORS

UL LISTED SF Certified

			WATERTIGHT (IP67)	SPLASHPROOF (IP44)			
				Standard Version (with cable gland)	Economical Version (with cable sleeve)	Low Profile Angled 90°	
	Poles and Wires	Voltage AC (Except where noted)	Clock Position of Ground Contact				
3	2P + G	250 DC	3	319315	311315	310315	316315
	1P + N + G	125	4	319316	311316	310316	316316
	2P + G	250	6	319306	311306	310306	316306
	1P + N + G	277	5	319317	311317	310317	316317
	2P + G	480	7	319319	311319	310319	316319
4	2P + N + G	125/250	12	318424	312424	310424	
	3P + G	3Ø250	9	318409	312409	310409	
	3P + G	3Ø480	7	318419	312419	310419	
	3P + G	3Ø600	5	318405	312405	310405	
5	3P + N + G	Barge Overflow	1	318501BL			
	3P + N + G	3ØY120/208	9	318509	312509	310509	
	3P + N + G	3ØY277/480	7	318519	312519	310519	
	3P + N + G	3ØY347/600	5	318505	312505	310505	
7	6P + G	250	9		312709	310709	
	6P + G	480	7		312719	310719	

BL devices are US Coast Guard required as per 46CFR Ch.1, 39.20-9.

FEMALE RECEPTACLES

Certified

			WATERTIGHT (IP67)			SPLASHPROOF (IP44)			
			Straight	Angled 15°	Angled 80°	Straight	Angled 15°	Angled 80°	
Poles and Wires	Voltage AC (Except where noted)	Clock Position of Ground Contact							
3	2P + G	250 DC	3	419315	519315	518315	410315	510315	514315
	1P + N + G	125	4	419316	519316	518316	410316	510316	514316
	2P + G	250	6	419306	519306	518306	410306	510306	514306
	1P + N + G	277	5	419317	519317	518317	410317	510317	514317
	2P + G	480	7	419319	519319	518319	410319	510319	514319
4	2P + N + G	125/250	12	419424	519424	518424	410424	510424	514424
	3P + G	3Ø250	9	419409	519409	518409	410409	510409	514409
	3P + G	3Ø480	7	419419	519419	518419	410419	510419	514419
	3P + G	3Ø600	5	419405	519405	518405	410405	510405	514405
5	3P + N + G	Barge Overflow	1	419501BL	519501BL	518501BL			
	3P + N + G	3ØY120/208	9	419509	519509	518509	410509	510509	514509
	3P + N + G	3ØY277/480	7	419519	519519	518519	410519	510519	514519
	3P + N + G	3ØY347/600	5	419505	519505	518505	410505	510505	514505
7	6P + G	250	9				411709		514709
	6P + G	480	7				411719		514719

Note: See pages 16 and 17 for surface mount receptacles and back boxes.

MALE INLETS





Certified

			WATERTIGHT (IP67)		SPLASHPROOF (IP44)			
			Angled 80°	Surface Mount*	Straight	Angled 80°	Surface Mount*	
Poles and Wires	Voltage AC (Except where noted)	Clock Position of Ground Contact						
3	2P + G	250 DC	3	619315	618315	615315	611315	
	1P + N + G	125	4	619316	618316	615316	611316	
	2P + G	250	6	619306	618306	615306	611306	
	1P + N + G	277	5	619317	618317	615317	611317	
	2P + G	480	7	619319	618319	615319	611319	
4	2P + N + G	125/250	12	619424	618424	615424	611424	616424
	3P + G	3Ø250	9	619409	618409	615409	611409	616409
	3P + G	3Ø480	7	619419	618419	615419	611419	616419
	3P + G	3Ø600	5	619405	618405	615405	611405	616405
5	3P + N + G	Barge Overflow	1	619501BL	618501BL			
	3P + N + G	3ØY120/208	9	619509	618509	615509	611509	616509
	3P + N + G	3ØY277/480	7	619519	618519	615519	611519	616519
	3P + N + G	3ØY347/600	5	619505	618505	615505	611505	616505
7	6P + G	250	9			615709	611709	616709
	6P + G	480	7			615719	611719	616719

BL devices are US Coast Guard required as per 46CFR Ch.1, 39.20-9.



MALE PLUGS

UL LISTED  Certified

			WATERTIGHT (IP67)	SPLASHPROOF (IP44)			
				Standard Version (with cable gland)	Economical Version (with cable sleeve)	Low Profile Angled 90°	
	Poles and Wires	Voltage AC (Except where noted)	Clock Position of Ground Contact				
3	2P + G	250 DC	3	239315	231315	230315	236315
	1P + N + G	125	4	239316	231316	230316	236316
	2P + G	250	6	239306	231306	230306	236306
	1P + N + G	277	5	239317	231317	230317	236317
	2P + G	480	7	239319	231319	230319	236319
4	2P + N + G	125/250	12	238424	232424	230424	236424
	3P + G	3Ø250	9	238409	232409	230409	236409
	3P + G	380/440*	3	238403*			
	3P + G	3Ø480	7	238419	232419	230419	236419
	3P + G	3Ø600	5	238405	232405	230405	236405
5	3P + N + G	50-600 400Hz	2	238502	232502	230502	236502
	3P + N + G	3ØY120/208	9	238509	232509	230509	236509
	3P + N + G	3ØY277/480	7	238519	232519	230519	236519
	3P + N + G	3ØY347/600	5	238505	232505	230505	236505
7	6P + G	250	9		232709	230709	
	6P + G	480	7		232719	230719	

FEMALE CONNECTORS







UL LISTED  Certified

			WATERTIGHT (IP67)	SPLASHPROOF (IP44)		
				Standard Version (with cable gland)	Economical Version (with cable sleeve)	
	Poles and Wires	Voltage AC (Except where noted)	Clock Position of Ground Contact			
3	2P + G	250 DC	3	339315	331315	330315
	1P + N + G	125	4	339316	331316	330316
	2P + G	250	6	339306	331306	330306
	1P + N + G	277	5	339317	331317	330317
	2P + G	480	7	339319	331319	330319
4	2P + N + G	125/250	12	338424	332424	330424
	3P + G	3Ø250	9	338409	332409	330409
	3P + G	380/440*	3	338403*		
	3P + G	3Ø480	7	338419	332419	330419
	3P + G	3Ø600	5	338405	332405	330405
5	3P + N + G	50-600 400Hz	2	338502	332502	330502
	3P + N + G	3ØY120/208	9	338509	332509	330509
	3P + N + G	3ØY277/480	7	338519	332519	330519
	3P + N + G	3ØY347/600	5	338505	332505	330505
7	6P + G	250	9		332709	330709
	6P + G	480	7		332719	330719

* Only for refrigerated containers. Supplied with stainless steel assembly screws and friction ring.

FEMALE RECEPTACLES





UL LISTED **SP** Certified

			WATERTIGHT (IP67)			SPLASHPROOF (IP44)			
			Straight	Angled 15°	Angled 80°	Straight	Angled 15°	Angled 80°	
Poles and Wires	Voltage AC (Except where noted)	Clock Position of Ground Contact							
3	2P + G	250 DC	3	439315	539315	538315	430315	530315	534315
	1P + N + G	125	4	439316	539316	538316	430316	530316	534316
	2P + G	250	6	439306	539306	538306	430306	530306	534306
	1P + N + G	277	5	439317	539317	538317	430317	530317	534317
	2P + G	480	7	439319	539319	538319	430319	530319	534319
4	2P + N + G	125/250	12	439424	539424	538424	430424	530424	534424
	3P + G	3Ø250	9	439409	539409	538409	430409	530409	534409
	3P + G	380/440*	3	439403*					
	3P + G	3Ø480	7	439419	539419	538419	430419	530419	534419
	3P + G	3Ø600	5	439405	539405	538405	430405	530405	534405
5	3P + N + G	50-600 400Hz	2	439502	539502	538502	430502	530502	534502
	3P + N + G	3ØY120/208	9	439509	539509	538509	430509	530509	534509
	3P + N + G	3ØY277/480	7	439519	539519	538519	430519	530519	534519
	3P + N + G	3ØY347/600	5	439505	539505	538505	430505	530505	534505
7	6P + G	250	9				431709		534709
	6P + G	480	7				431719		534719

Note: See pages 16 and 17 for surface mount receptacles and back boxes.

MALE INLETS



UL LISTED **SP** Certified

			WATERTIGHT (IP67)		SPLASHPROOF (IP44)			
			Angled 80°	Surface Mount**	Straight	Angled 80°	Surface Mount**	
Poles and Wires	Voltage AC (Except where noted)	Clock Position of Ground Contact						
3	2P + G	250 DC	3	639315	638315	635315	631315	636315
	1P + N + G	125	4	639316	638316	635316	631316	636316
	2P + G	250	6	639306	638306	635306	631306	636306
	1P + N + G	277	5	639317	638317	635317	631317	636317
	2P + G	480	7	639319	638319	635319	631319	636319
4	2P + N + G	125/250	12	639424	638424	635424	631424	636424
	3P + G	3Ø250	9	639409	638409	635409	631409	636409
	3P + G	380/440*	3	639403*	638403*			
	3P + G	3Ø480	7	639419	638419	635419	631419	636419
	3P + G	3Ø600	5	639405	638405	635405	631405	636405
5	3P + N + G	50-600 400Hz	2	639502	638502	635502	631502	636502
	3P + N + G	3ØY120/208	9	639509	638509	635509	631509	636509
	3P + N + G	3ØY277/480	7	639519	638519	635519	631519	636519
	3P + N + G	3ØY347/600	5	639505	638505	635505	631505	636505
7	6P + G	250	9			635709	631709	636709
	6P + G	480	7			635719	631719	636719

* Only for refrigerated containers.



MALE PLUGS

 **LISTED**  **Certified**

			WATERTIGHT (IP67)	SPLASHPROOF (IP44)		
				Standard Version (with cable gland)	Economical Version (with cable sleeve)	
Poles and Wires (With pilot)	Voltage AC (Except where noted)	Clock Position of Ground Contact				
3	2P + G	250 DC	3	269315	261315	260315
	1P + N + G	125	4	269316	261316	260316
	2P + G	250	6	269306	261306	260306
	1P + N + G	277	5	269317	261317	260317
	2P + G	480	7	269319	261319	260319
4	2P + N + G	125/250	12	269424	261424	260424
	3P + G	3Ø250	9	269409	261409	260409
	3P + G	3Ø480	7	269419	261419	260419
	3P + G	3Ø600	5	269405	261405	260405
5	3P + N + G	50-600 400Hz	2	269502	261502	260502
	3P + N + G	3ØY120/208	9	269509	261509	260509
	3P + N + G	3ØY277/480	7	269519	261519	260519
	3P + N + G	3ØY347/600	5	269505	261505	260505







FEMALE CONNECTORS

 **LISTED**  **Certified**

			WATERTIGHT (IP67)	SPLASHPROOF (IP44)		
				Standard Version (with cable gland)	Economical Version (with cable sleeve)	
Poles and Wires (With pilot)	Voltage AC (Except where noted)	Clock Position of Ground Contact				
3	2P + G	250 DC	3	369315	361315	360315
	1P + N + G	125	4	369316	361316	360316
	2P + G	250	6	369306	361306	360306
	1P + N + G	277	5	369317	361317	360317
	2P + G	480	7	369319	361319	360319
4	2P + N + G	125/250	12	369424	361424	360424
	3P + G	3Ø250	9	369409	361409	360409
	3P + G	3Ø480	7	369419	361419	360419
	3P + G	3Ø600	5	369405	361405	360405
5	3P + N + G	50-600 400Hz	2	369502	361502	360502
	3P + N + G	3ØY120/208	9	369509	361509	360509
	3P + N + G	3ØY277/480	7	369519	361519	360519
	3P + N + G	3ØY347/600	5	369505	361505	360505

FEMALE RECEPTACLES





UL LISTED **SP Certified**

			WATERTIGHT (IP67)			SPLASHPROOF (IP44)			
			Straight	Angled 15°	Angled 80°	Straight	Angled 15°	Angled 80°	
Poles and Wires (With pilot)	Voltage AC (Except where noted)	Clock Position of Ground Contact							
3	2P + G	250 DC	3	469315	569315	568315	460315	560315	564315
	1P + N + G	125	4	469316	569316	568316	460316	560316	564316
	2P + G	250	6	469306	569306	568306	460306	560306	564306
	1P + N + G	277	5	469317	569317	568317	460317	560317	564317
	2P + G	480	7	469319	569319	568319	460319	560319	564319
4	2P + N + G	125/250	12	469424	569424	568424	460424	560424	564424
	3P + G	3Ø250	9	469409	569409	568409	460409	560409	564409
	3P + G	3Ø480	7	469419	569419	568419	460419	560419	564419
	3P + G	3Ø600	5	469405	569405	568405	460405	560405	564405
5	3P + N + G	50-600 400Hz	2	469502	569502	568502	460502	560502	564502
	3P + N + G	3ØY120/208	9	469509	569509	568509	460509	560509	564509
	3P + N + G	3ØY277/480	7	469519	569519	568519	460519	560519	564519
	3P + N + G	3ØY347/600	5	469505	569505	568505	460505	560505	564505

Note: See pages 16 and 17 for surface mount receptacles and back boxes.

MALE INLETS

UL LISTED **SP Certified**

			WATERTIGHT (IP67)		SPLASHPROOF (IP44)		
			Angled 80°	Surface Mount*	Straight	Angled 80°	
Poles and Wires (With pilot)	Voltage AC (Except where noted)	Clock Position of Ground Contact					
3	2P + G	250 DC	3	669315	668315		661315
	1P + N + G	125	4	669316	668316		661316
	2P + G	250	6	669306	668306		661306
	1P + N + G	277	5	669317	668317		661317
	2P + G	480	7	669319	668319		661319
4	2P + N + G	125/250	12	669424	668424		661424
	3P + G	3Ø250	9	669409	668409		661409
	3P + G	3Ø480	7	669419	668419		661419
	3P + G	3Ø600	5	669405	668405		661405
5	3P + N + G	50-600 400Hz	2	669502	668502	665502	661502
	3P + N + G	3ØY120/208	9	669509	668509	665509	661509
	3P + N + G	3ØY277/480	7	669519	668519	665519	661519
	3P + N + G	3ØY347/600	5	669505	668505	665505	661505

MALE PLUGS

UL LISTED SP Certified

WATERTIGHT (IP67)



	Poles and Wires (With pilot)	Voltage AC (Except where noted)	Clock Position of Ground Contact	
3	2P + G	250 DC	3	279315
	1P + N + G	125	4	279316
	2P + G	250	6	279318
	1P + N + G	277	5	279317
	2P + G	480	7	279319
4	2P + N + G	125/250	12	279424
	3P + G	3Ø250	9	279421
	3P + G	3Ø480	7	279419
	3P + G	3Ø600	5	279417
5	3P + N + G	3ØY120/208	9	279521
	3P + N + G	3ØY277/480	7	279519
	3P + N + G	3ØY347/600	5	279517

FEMALE CONNECTORS

UL LISTED SP Certified

WATERTIGHT (IP67)





	Poles and Wires (With pilot)	Voltage AC (Except where noted)	Clock Position of Ground Contact	
3	2P + G	250 DC	3	379315
	1P + N + G	125	4	379316
	2P + G	250	6	379318
	1P + N + G	277	5	379317
	2P + G	480	7	379319
4	2P + N + G	125/250	12	379424
	3P + G	3Ø250	9	379421
	3P + G	3Ø480	7	379419
	3P + G	3Ø600	5	379417
5	3P + N + G	3ØY120/208	9	379521
	3P + N + G	3ØY277/480	7	379519
	3P + N + G	3ØY347/600	5	379517

Note: 100-Amp devices are only available in IP67-Watertight configuration.

FEMALE RECEPTACLES



UL LISTED **SP Certified**

			WATERTIGHT (IP67)		
			Straight	Angled 15°	
Poles and Wires (With pilot)	Voltage AC (Except where noted)	Clock Position of Ground Contact			
3	2P + G	250 DC	3	479315	579315
	1P + N + G	125	4	479316	579316
	2P + G	250	6	479318	579318
	1P + N + G	277	5	479317	579317
	2P + G	480	7	479319	579319
4	2P + N + G	125/250	12	479424	579424
	3P + G	3Ø250	9	479421	579421
	3P + G	3Ø480	7	479419	579419
	3P + G	3Ø600	5	479417	579417
5	3P + N + G	3ØY120/208	9	479521	579521
	3P + N + G	3ØY277/480	7	479519	579519
	3P + N + G	3ØY347/600	5	479517	579517

Note: See pages 16 and 17 for surface mount receptacles and back boxes.

MALE INLETS

UL LISTED **SP Certified**

			WATERTIGHT (IP67)		
			Straight	Surface Mount*	
Poles and Wires (With pilot)	Voltage AC (Except where noted)	Clock Position of Ground Contact			
3	2P + G	250 DC	3	679315	678315
	1P + N + G	125	4	679316	678316
	2P + G	250	6	679318	678318
	1P + N + G	277	5	679317	678317
	2P + G	480	7	679319	678319
4	2P + N + G	125/250	12	679424	678424
	3P + G	3Ø250	9	679421	678421
	3P + G	3Ø480	7	679419	678419
	3P + G	3Ø600	5	679417	678417
5	3P + N + G	3ØY120/208	9	679521	678521
	3P + N + G	3ØY277/480	7	679519	678519
	3P + N + G	3ØY347/600	5	679517	678517

SURFACE MOUNT RECEPTACLES



			WATERTIGHT (IP67)				SPLASHPROOF (IP44)			
			20 Amps	30 Amps	60 Amps	100 Amps	20 Amps	30 Amps	60 Amps	
3	2P + G	250 DC	3							
	1P + N + G	125	4	119315	139315	179315	111315	131315		
	2P + G	250	6	119316	139316	179316	111316	131316		
	1P + N + G	277	5	119306	139306	179318	111306	131306		
	2P + G	480	7	119317	139317	179317	111317	131317		
4	2P + G	480	7	119319	139319	179319	111319	131319		
	2P + N + G	125/250	12	119424	139424	169424	179424	111424	131424	161424
	3P + G	3Ø250	9	119409	139409	169409	179421	111409	131409	161409
	3P + G	380/440**	3		139403*					
	3P + G	3Ø480	7	119419	139419	169419	179419	111419	131419	161419
5	3P + G	3Ø600	5	119405	139405	169405	179417	111405	131405	161405
	3P + N + G	Barge Overflow	1	119501BL						
	3P + N + G	3ØY120/208	9	119509	139509	169509	179521	111509	131509	161509
	3P + N + G	3ØY277/480	7	119519	139519	169519	179519	111519	131519	161519
7	3P + N + G	3ØY347/600	5	119505	139505	169505	179517	111505	131505	161505
	6P + G	250	9					111709	131709	
	6P + G	480	7					111719	131719	

* Only for refrigerated containers. **Surface mount receptacles combine a back box and receptacle into one compact device.



CEEtyp - TEST PLUGS



Phase sequence control plugs quickly allow for inspection of phase rotational direction within seconds. The devices are provided with two LEDs:

- GREEN lamp lights: phase sequence is correct.....
- RED lamp lights: phase sequence is wrong.....
- GREEN & RED lamps light: one phase is missing.....

ORDERING INFORMATION

Amps	No. of Wires	RANGE Voltage AC	Clock Position of Ground Contact	Male Plug
16	3P + G	110V - 690V	6	
16	3P + N + G	110V - 690V	6	210406DF
32	3P + G	110V - 690V	6	210DF
32	3P + N + G	110V - 690V	6	230406DF
63	3P + G	110V - 690V	6	230DF
63	3P + N + G	110V - 690V	6	260406DF
63	3P + N + G	110V - 690V	6	260DF

CEEtyp- Phase Inverters



Phase inverters: Incorrectly installed rotating fields can easily be set right by quickly changing the polarity of the motor without having to rewire the phasing. Three-steps, three-minutes or less, job complete!

- Step 1 - Turn the power off
- Step 2 - Rotate the phase pins
- Step 3 - Turn the power on

Questions regarding the Phase Inverter? Call us today!

ORDERING INFORMATION

Amps	No. of Wires	Voltage AC	Clock Position of Ground Contact	Male Plug
16	3P + N + G	400	6	
32	3P + N + G	400	6	210PH
				230PH

BACK BOXES for use with Walther straight watertight and splashproof receptacles.

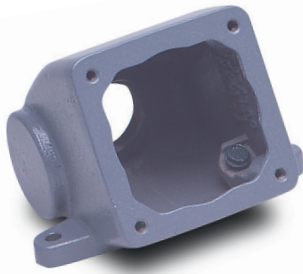

Cat. No.	Description	Hub Size	Dimensions (inches)							Cubic Inch Capacity
			A	B	C	D	E	F	G	
BE3-B75	20° angle for 20A, 4 and 5 wire recepts. and all 30A recepts.	3/4"	3.34	0.97	1.12	4.12	4.00	0.25		20.4
BE3-B100		1"								
BE6-B125	20° angle for all 60A receptacles	1 1/4"	4.41	1.41	2.09	5.63	5.00	0.28	3.00	59.7
BE6-B150		1 1/2"								
BE10-B150	20° angle for all 100A receptacles	1 1/2"	5.18	1.78	2.50	7.71	5.50	.34	4.00	96.6
BE10-B200		2"								

Cast Aluminum Junction Boxes for Straight Watertight and Splashproof Female Receptacles

Epoxy-coated junction boxes are corrosion resistant and designed to pass the 500-hour salt spray test, the UL hosedown and external icing tests.

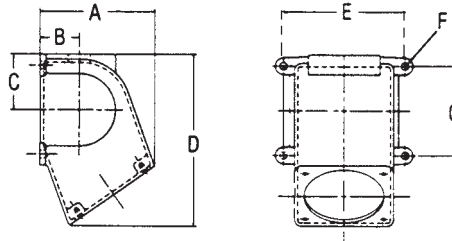

BACK BOX ADAPTER PLATES for use with Hubbell back boxes.

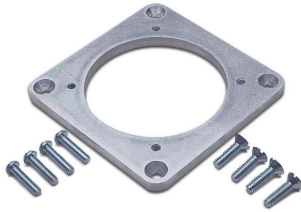

Cat. No.	Walther Receptacle	For use with Hubbell Back Box
BB20-3W	20A, 3 Wire	BB201W, BB301W, FT202W or FT302W
BB20-345W	20A, 4 & 5 Wire 30A, 3, 4 & 5 Wire	BB201W, BB301W, FT202W or FT302W
BB60-345W	60A, 3, 4 & 5 Wire	BB601W, BB602W or FW60/100
BB100-345W	100A, 3, 4 & 5 Wire	BB1001W, BB1002W or FW60/100



Can your current device withstand this type of abuse?



Built tough for the most demanding use!



Oil-Grime-Water-we can take it all!

PG THREAD TO NPT THREAD ADAPTERS



Cat. No.	Description	Std. Pkg.
PG11-38	PG11 to 3/8" NPT Adapter	25
PG11-50	PG11 to 1/2" NPT Adapter	25
PG135-50	PG13,5 to 1/2" NPT Adapter	25
PG16-50	PG16 to 1/2" NPT Adapter	25
PG21-75	PG21 to 3/4" NPT Adapter	25
PG29-100	PG29 to 1" NPT Adapter	10
PG29-125	PG29 to 1 1/4" NPT Adapter	5
PG36-125	PG36 to 1 1/4" NPT Adapter	5

For PG thread sizes to NPT thread sizes not shown, consult technical service for price, delivery and minimum order quantities.

WATERTIGHT CLOSURE CAPS for use with watertight male plugs and inlets



Cat. No.	Poles and Wires	Amperage Rating	Std. Pkg Quantity
613300	3 Wire	20	5
633400		30	5
663500		60	2
673500		100	2
613400	4 Wire	20	5
633400		30	5
663500		60	2
673500		100	2
613500	5 Wire	20	5
633500		30	5
663500		60	2
673500		100	2

SPLASHPROOF CLOSURE CAPS for use with splashproof male plugs and inlets



Cat. No.	Poles and Wires	Amperage Rating	Std. Pkg Quantity
614300	3 Wire	20	5
634400		30	5
664500		60	2
614400	4 Wire	20	5
634400		30	5
664500		60	2
614500	5 Wire	20	5
634500		30	5
664500		60	2

PRE-INSTALLED CLOSURE CAPS



Closure caps provide watertight or splashproof protection to disconnected plugs and inlets. The possibility of removing or misplacing the cap can be eliminated by securing the chain or nylon strap to the inlet flange. If the closure cap will be fastened to a plug, Walther can pre-install the cap on the device. This factory installation assures safe and reliable utilization of the two components. Contact customer service for ordering information.

ELECTRICAL

Insulation Resistance Per IEC60309-1, Clause 19	500V for 1 min. Resistance $\geq 5M \Omega$
Dielectric Strength Per IEC60309-1, Clause 19	3000V for 1 min.
Norm. Operation, Connect & Disconnect Cycles Per IEC60309-1, Clause 21	See Table 1
Breaking Capacity Per IEC60309-1, Clause 20	Tested at 110 % of the rated operating voltage and 125% of the rated current.
Temperature Rise Per IEC60309-1, Clause 22	Maximum 50 K rise at full rated current.

MECHANICAL

Cable Secureness Per IEC60309, Clause 23	See Table 2
Impact Per IEC60309, Clause 24	A device is wired with a 2.25m length of flexible cord and dropped from a height of 75 cm, 8 times. The device is then tested for applicable degrees of protection against moisture.

ENVIRONMENTAL

Flammability	Self-extinguishing Per IEC60309-1, Clause 27
Ambient Temperature Range	Minimum: -25°C with impact Maximum: 90°C
Moisture Resistance	Watertight (IP67): Device immersed for 24 hours in water at a temp. of 25°C, the highest point of the device being 5cm (2") below the water level. Splashproof (IP44): Device is sprayed with water for 10 minutes and immediately afterwards subjected to splashing water in all directions (360°).
UV Resistance	Exposed plastic materials are UV stabilized.



DECLARATION OF CONFORMITY

WALTHER WERKE, Ferdinand Walther GmbH
Ramsener Strasse 6
67304 Eisenberg

We declare, under our sole responsibility, the conformity of the following products and standards:

Plugs and Sockets (Pin and Sleeve devices)
DIN EN 60 309, T. 1
DIN EN 60 309, T. 2

This declaration of conformity is according to the EC regulations 73/23, 91/368 and 89/336 (Low Voltage Directive), module A, in consideration of DIN EN 45 014.

Minimum test requirements

TABLE 1

Device Rating Amperes	Cycles with Load at Rated Current and Voltage	No-Load Cycles	Sequence
16	5000 p.f of 0.6	0	-
32	1000 p.f of 0.6	1000	Alternating
63	1000 p.f of 0.6	1000	Alternating
125	250 p.f of 0.7	250	Alternating

The test sequence is conducted by using a no-load, followed by a load sequence.

TABLE 2

Device Rating Amperes	Force	Torque	Maximum Displacement
	N	Nm	mm
16	80	0.350	2
32	100	0.425	2
63	120	0.8	2
125	200	1.5	2

The flexible cord or cable is twisted and pulled. Values for the applied twisting torque and force of pull are shown in Table 2. In all cases the cord displacement is less than 2mm.







DIN EN ISO 9001 Certificate Registration No. 4678-01







MALE PLUGS

 LISTED

			WATERTIGHT (IP67)	SPLASHPROOF (IP44)		
					with cable gland	with cable sleeve
3	2P + G	110				
		230				
		400				
4	3P + G	110				
		230				
		400				
		440				
		500				
		>50 (100-300Hz)				
		>50 (300-500Hz)				
5	3P + N + G	110				
		230				
		400				
		440				
7	6P + G	400				







FEMALE CONNECTORS (Couplers)

 LISTED

			WATERTIGHT (IP67)	SPLASHPROOF (IP44)		
					with cable gland	with cable sleeve
3	2P + G	110				
		230				
		400				
4	3P + G	110				
		230				
		400				
		440				
		500				
		>50 (100-300Hz)				
		>50 (300-500Hz)				
5	3P + N + G	110				
		230				
		400				
		440				
7	6P + G	400				

FEMALE PANEL MOUNTED SOCKET-OUTLET







UL LISTED

			WATERTIGHT (IP67)			SPLASHPROOF (IP44)		
			Straight	Angled 15°	Angled 80°	Straight	Angled 15°	Angled 80°
3	2P + G	110						
		230						
		400						
4	3P + G	110						
		230						
		400						
		440						
		500						
		>50 (100-300Hz)						
		>50 (300-500Hz)						
5	3P + N + G	110						
		230						
		400						
		440						
7	6P + G	400				411706		514706

Note: See page 28 for surface mount socket-outlets.





MALE APPLIANCE PLUG (Inlet)

UL LISTED

			WATERTIGHT (IP67)		SPLASHPROOF (IP44)			
			Angled 80°	Surface Mount	Straight	Angled 80°	Surface Mount External Mounting	Surface Mount Internal Mounting
3	2P + G	110						
		230						
		400						
4	3P + G	110						
		230						
		400						
		440						
		500						
		>50 (100-300Hz)						
		>50 (300-500Hz)						
5	3P + N + G	110						
		230						
		400						
		440						
7	6P + G	400			615706	611706	610706	616706



MALE PLUGS

 LISTED

			WATERTIGHT (IP67)	SPLASHPROOF (IP44)		
					with cable gland	with cable sleeve
No. of Wires	Voltage AC	Clock Position of Ground Contact				
3	2P + G	110	239304	231304	230304	236304
		230	239306	231306	230306	236306
		400	239309	231309	230309	236309
4	3P + G	110	239404	231404	230404	236404
		230	239409	231409	230409	236409
		400	239406	231406	230406	236406
		380/440*	239403*			
		440	239411	231411	230411	236411
		500	239407	231407	230407	236407
		>50 (100-300Hz)	239410	231410	230410	236410
>50 (300-500Hz)	239402	231402	230402	236402		
5	3P + N + G	110	239504	231504	230504	236504
		230	239509	231509	230509	236509
		400	239	231	230	236
		440	239511	231511	230511	236511
7	6P + G	400		231706	230706	

FEMALE CONNECTORS (Couplers)

 LISTED

			WATERTIGHT (IP67)	SPLASHPROOF (IP44)	
					with cable gland
No. of Wires	Voltage AC	Clock Position of Ground Contact			
3	2P + G	110	339304	331304	330304
		230	339306	331306	330306
		400	339309	331309	330309
4	3P + G	110	339404	331404	330404
		230	339409	331409	330409
		400	339406	331406	330406
		380/440*	339403*		
		440	339411	331411	330411
		500	339407	331407	330407
		>50 (100/300Hz)	339410	331410	330410
>50 (300/500Hz)	339402	331402	330402		
5	3P + N + G	110	339504	331504	330504
		230	339509	331509	330509
		400	339	331	330
		440	339511	331511	330511
7	6P + G	400		331706	330706

* Only for refrigerated containers.

FEMALE PANEL MOUNTED SOCKET-OUTLET

UL LISTED

			WATERTIGHT (IP67)			SPLASHPROOF (IP44)			
			Straight	Angled 15°	Angled 80°	Straight	Angled 15°	Angled 80°	
3	2P + G	110	4	439304	539304	538304	430304	530304	534304
		230	6	439306	539306	538306	430306	530306	534306
		400	9	439309	539309	538309	430309	530309	534309
4	3P + G	110	4	439404	539404	538404	430404	530404	534404
		230	9	439409	539409	538409	430409	530409	534409
		400	6	439406	539406	538406	430406	530406	534406
		380/440*	3	439403*					
		440	11	439411	539411	538411	430411	530411	534411
		500	7	439407	539407	538407	430407	530407	534407
		>50 (100-300Hz)	10	439410	539410	538410	430410	530410	534410
>50 (300-500Hz)	2	439402	539402	538402	430402	530402	534402		
5	3P + N + G	110	4	439504	539504	538504	430504	530504	534504
		230	9	439509	539509	538509	430509	530509	534509
		400	6	439	539	538	430	530	534
		440	11	439511	539511	538511	430511	530511	534511
7	6P + G	400	6				431706		534706

Note: See page 28 for surface mount socket-outlets.

MALE APPLIANCE PLUG (Inlet)



UL LISTED

			WATERTIGHT (IP67)		SPLASHPROOF (IP44)				
			Angled 80°	Surface Mount	Straight	Angled 80°	Surface Mount External Mounting	Surface Mount Internal Mounting	
3	2P + G	110	4	639304	638304	635304	631304	630304	636304
		230	6	639306	638306	635306	631306	630306	636306
		400	9	639309	638309	635309	631309	630309	636309
4	3P + G	110	4	639404	638404	635404	631404	630404	636404
		230	9	639409	638409	635409	631409	630409	636409
		400	6	639406	638406	635406	631406	630406	636406
		380/440*	3	639403*	638403*				
		440	11	639411	638411	635411	631411	630411	636411
		500	7	639407	638407	635407	631407	630407	636407
		>50 (100-300Hz)	10	639410	638410	635410	631410	630410	636410
>50 (300-500Hz)	2	639402	638402	635402	631402	630402	636402		
5	3P + N + G	110	4	639504	638504	635504	631504	630504	636504
		230	9	639509	638509	635509	631509	630509	636509
		400	6	639	638	635	631	630	636
		440	11	639511	638511	635511	631511	630511	636511
7	6P + G	400	6			635706	631706	630706	636706

* Only for refrigerated containers.



MALE PLUGS

 LISTED

			WATERTIGHT (IP67)	SPLASHPROOF (IP44)	
					with cable gland
No. of Wires	Voltage AC	Clock Position of Ground Contact			
3	2P + G	110	269304	261304	260304
		230	269306	261306	260306
		400	269309	261309	260309
4	3P + G	110	269404	261404	260404
		230	269409	261409	260409
		400	269406	261406	260406
		440	269411	261411	260411
		500	269407	261407	260407
5	3P + N + G	110	269504	261504	260504
		230	269509	261509	260509
		400	269	261	260
		440	269511	261511	260511







FEMALE CONNECTORS (Couplers)

 LISTED

			WATERTIGHT (IP67)	SPLASHPROOF (IP44)	
					with cable gland
No. of Wires	Voltage AC	Clock Position of Ground Contact			
3	2P + G	110	369304	361304	360304
		230	369306	361306	360306
		400	369309	361309	360309
4	3P + G	110	369404	361404	360404
		230	369409	361409	360409
		400	369406	361406	360406
		440	369411	361411	360411
		500	369407	361407	360407
5	3P + N + G	110	369504	361504	360504
		230	369509	361509	360509
		400	369	361	360
		440	369511	361511	360511

FEMALE PANEL MOUNTED SOCKET-OUTLET





 LISTED

			WATERTIGHT (IP67)			SPLASHPROOF (IP44)		
			Straight	Angled 15°	Angled 80°	Straight	Angled 15°	Angled 80°
3	2P + G	110						
		230	469304	569304	568304	460304	560304	564304
		400	469306	569306	568306	460306	560306	564306
4	3P + G	110	469309	569309	568309	460309	560309	564309
		230	469404	569404	568404	460404	560404	564404
		400	469409	569409	568409	460409	560409	564409
		440	469406	569406	568406	460406	560406	564406
		500	469411	569411	568411	460411	560411	564411
5	3P + N + G	110	469407	569407	568407	460407	560407	564407
		230	469504	569504	568504	460504	560504	564504
		400	469509	569509	568509	460509	560509	564509
		440	469	569	568	460	560	564
			469511	569511	568511	460511	560511	564511

Note: See page 28 for surface mount receptacles.

MALE APPLIANCE PLUG (Inlet)

 LISTED

			WATERTIGHT (IP67)		SPLASHPROOF (IP44)	
			Angled 80°	Surface Mount	Straight	Angled 80°
3	2P + G	110				
		230	669304	668304		661304
		400	669306	668306		661306
4	3P + G	110	669309	668309		661309
		230	669404	668404		661404
		400	669409	668409		661409
		440	669406	668406		661406
		500	669411	668411		661411
5	3P + N + G	110	669407	668407		661407
		230	669504	668504	665504	661504
		400	669509	668509	665509	661509
		440	669	668	665	661
			669511	668511	665511	661511

MALE PLUGS

UL LISTED

WATERTIGHT (IP67)



No. of Wires	Voltage AC	Clock Position of Ground Contact		
3	2P + G	110	4	279304
		230	6	279306
		400	9	279309
4	3P + G	110	4	279404
		230	9	279409
		400	6	279406
		440	11	279411
		500	7	279407
5	3P + N + G	110	4	279504
		230	9	279509
		400	6	279
		440	11	279511

FEMALE CONNECTORS (Couplers)

UL LISTED

WATERTIGHT (IP67)





No. of Wires	Voltage AC	Clock Position of Ground Contact		
3	2P + G	110	4	379304
		230	6	379306
		400	9	379309
4	3P + G	110	4	379404
		230	9	379409
		400	6	379406
		440	11	379411
		500	7	379407
5	3P + N + G	110	4	379504
		230	9	379509
		400	6	379
		440	11	379511

Note: 125-Amp devices are only available in IP67-Watertight configuration.

FEMALE PANEL MOUNTED SOCKET-OUTLET



UL LISTED

			WATERTIGHT (IP67)		
			Straight	Angled 15°	
No. of Wires	Voltage AC	Clock Position of Ground Contact			
3	2P + G	110	4	479304	579304
		230	6	479306	579306
		400	9	479309	579309
4	3P + G	110	4	479404	579404
		230	9	479409	579409
		400	6	479406	579406
		440	11	479411	579411
		500	7	479407	579407
5	3P + N + G	110	4	479504	579504
		230	9	479509	579509
		400	6	479	579
		440	11	479511	579511

Note: See page 28 for surface mount receptacles.

MALE APPLIANCE PLUG (Inlet)

UL LISTED

			WATERTIGHT (IP67)		
			Straight	Surface Mount	
No. of Wires	Voltage AC	Clock Position of Ground Contact			
3	2P + G	110	4	679304	678304
		230	6	679306	678306
		400	9	679309	678309
4	3P + G	110	4	679404	678404
		230	9	679409	678409
		400	6	679406	678406
		440	11	679411	678411
		500	7	679407	678407
5	3P + N + G	110	4	679504	678504
		230	9	679509	678509
		400	6	679	678
		440	11	679511	678511

SURFACE MOUNT SOCKET-OUTLETS



(Internal Mounting)

			WATERTIGHT (IP67)				SPLASHPROOF (IP44)		
			16 Amps	32 Amps	63 Amps	125 Amps	16 Amps	32 Amps	63 Amps
3	2P + G	110	4						
		230	6						
		400	9						
4	3P + G	110	4						
		230	9						
		400	6						
		440	11						
		500	7						
		>50 (100-300Hz)	10						
		>50 (300-500Hz)	2						
5	3P + N + G	110	4						
		230	9						
		400	6						
		440	11						
7	6P + G	400	6						

SURFACE MOUNT SOCKET-OUTLETS



(External Mounting)

			SPLASHPROOF (IP44)		
			16 Amps	32 Amps	
3	2P + G	110	4		
		230	6		
		400	9		
4	3P + G	110	4		
		230	9		
		400	6		
		440	11		
		500	7		
		>50 (100-300Hz)	10		
		>50 (300-500Hz)	2		
5	3P + N + G	110	4		
		230	9		
		400	6		
		440	11		
7	6P + G	400	6		

NEW PRODUCT - NEW CEEtyp GENERATION



Standard screw-terminal version: faster and safer



Cable gland: Automatic strain relief plus sealing all in one go



Double safety: two contact screws for vibration-proof wiring



Color coding: safe identification of conductors



The standard version: with screw terminals

Doubly safe: with 2 connection screws per terminal

Automatic cable gland: the absolutely safe solution

Example for 6 h types

Former part nos.:	Today's part no.:
210 211 212	210
310 311 312	310
230 231 232	230
330 331 332	330







High technology moulding, a patented WALTHER system for perfect sealing

For expert safety: totally splashproof, including strain relief

Durable locking: Fasten front and back part until audible snap

ORDERING INFORMATION

 3 P + N + E	Ampère	Poles	110 V	230 V	400 V	Conductor cross section	Cable diameter			
			50 a. 60 Hz 5pole 4h	50 a. 60 Hz 5pole 9h	50 a. 60 Hz 5pole 6h					
Part numbers										
 pic. 210	16	5	210 504	210 509	210	1 - 4 mm ²	7,5 - 19,5 mm	10/60	176	
	32	5	230 504	230 509	230	2,5 - 6 mm ²	10 - 24,5 mm	10/60	250	
CEE Male Plug ⚠ IP 44, with screw terminals										
 pic. 310	16	5	310 504	310 509	310	1 - 4 mm ²	7,5 - 19,5 mm	10/60	219	
	32	5	330 504	330 509	330	2,5 - 6 mm ²	10 - 24,5 mm	10/60	311	
CEE Female Connector (coupler) ⚠ IP 44, with screw terminals										

Consult customer service for other amperage and voltage ratings and configurations.

The New Walther Watertight Solution!

The new style Walther IP67 plugs and connectors have improved sealing, fast, safe and tight cable gland. The new Walther IP67 plugs and connectors also offer a provision for a padlock to comply with OSHA Lockout/Tagout requirements.



Double sealing groove:
For a larger sealing surface and thus higher tightness.



Protecting cap:
The cap is always at hand since it is undetachably fixed on the bayonet ring

Padlockable:
Protection against unauthorized disconnection from the electric circuit. Stay OSHA Compliant!

Modes of Connection

You can choose between:

■ **screw terminals:**
2 connection screws per contact, already with 16 A - for double safety

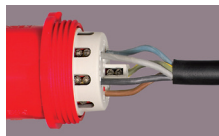

■ **screwless version:**
Centrepiece is the distributor ring. When inserting the wires into the slots they are bent by 180°. This serves as anchor. By inserting the distributor ring into the front part and screwing down the back part all wires are contacted in one go.

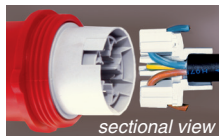

New Product Features

- Pleasing product design
- Cable gland for better strain relief and tightness.
- Opened hinged lid snaps automatically into closed position when let loose. Thereby increased contact protection even when lid is not yet screwed down.
- Unlimited strain relief with the screwless version - nobody will be able to pull this cable out anymore.
- Padlockable - as protection against unauthorized disconnection from the circuit
- Double sealing groove for more tightness
- Captive protecting cap







Assembly

- Just screw front and back part together - ready.
- Only screw down cable gland - quick and easy.
- To attach the padlock simply insert its shackle into the hole on the bayonet ring
- Plug and socket, 16 A and 32 A
- Protecting cap (accessory)
- padlock (accessory)



CEEtyp Plugs and Sockets

Range of products

 2P+E  3P+E  3P+N+E	Ampère	Poles	110 V 50 a. 60 Hz			230 V 50 a. 60 Hz			400 V 50 a. 60 Hz			Conductor cross section	Cable diameter				
			3pole 4h	4pole 4h	5pole 4h	3pole 6h	4pole 9h	5pole 9h	3pole 9h	4pole 6h	5pole 6h						
Part Numbers																	
	16	4	219 404			219 409			219 406		1 - 2,5 mm ²	7,5 - 18,5 mm	10	212			
	16	5	219 504			219 509			219				10	236			
	32	3	239 304			239 306			239 309		2,5 - 6 mm ²	10 - 22,5 mm	10	290			
	32	4	239 404			239 409			239 406				10	300			
	32	5	239 504			239 509			239				10	340			
	16	4	219 404 SL			219 409 SL			219 406 SL		1 - 2,5 mm ²	7,5 - 18,5 mm	10	212			
	16	5	219 504 SL			219 509 SL			219 SL				10	236			
	32	3	239 304 SL			239 306 SL			239 309 SL		2,5 - 6 mm ²	10 - 22,5 mm	10	290			
	32	4	239 404 SL			239 409 SL			239 406 SL				10	300			
	32	5	239 504 SL			239 509 SL			239 SL				10	340			
	CEE Plug IP 67, with screw terminals																
		16	4	319 404			319 409			319 406		1 - 2,5 mm ²	7,5 - 18,5 mm	10	268		
16		5	319 504			319 509			319				10	298			
32		3	339 304			339 306			339 309		2,5 - 6 mm ²	10 - 22,5 mm	10	351			
32		4	339 404			339 409			339 406				10	369			
32		5	339 504			339 509			339				10	415			
16		4	319 404 SL			319 409 SL			319 406 SL		1 - 2,5 mm ²	7,5 - 18,5 mm	10	268			
16		5	319 504 SL			319 509 SL			319 SL				10	298			
32		3	339 304 SL			339 306 SL			339 309 SL		2,5 - 6 mm ²	10 - 22,5 mm	10	351			
32		4	339 404 SL			339 409 SL			339 406 SL				10	369			
32		5	339 504 SL			339 509 SL			339 SL				10	415			
CEE Couplers IP 67, with screw terminals																	

Consult customer service for other amperage and voltage ratings and configurations.

* "SL" UL Listing Pending

Well hidden from View!

It is necessary that electrical installations on stages function without interruption and not be a distraction to the viewers.

The Walther Electric Solution:

Black devices which prevent bothersome light reflections and thus make the electrical installation on stages almost "invisible"!

Standard Style

New Light & Stage Style















Now You See It

Now You Don't

Male Plugs IP 44 for Light & Stage Applications

IEC/EN 60 309

		   2 P+E 3 P+E 3 P+N+E			Amperage	Poles	110 V 50 a. 60 Hz <small>3pole 4pole 5pole 4h 4h 4h</small>	230 V 50 a. 60 Hz <small>3pole 4pole 5pole 6h 9h 9h</small>	400 V 50 a. 60 Hz <small>3pole 4pole 5pole 9h 6h 6h</small>	500 V 50 a. 60 Hz <small>3pole 4pole 5pole 7h 7h 7h</small>		
Part numbers												
 231SW	16	3					211 306 SW			10	112	
	16	4						211 406 SW		10	154	
	16	5						211 SW		10	170	
	32	3				231 306 SW				10	211	
	32	4						231 406 SW		10	217	
	32	5						231 SW		10	240	
	63	3				261 306 SW				5	475	
	63	4						261 406 SW		5	566	
	63	5						261 SW		5	613	
125	3				279 306 SW¹⁾				2	1185		
125	4							279 406 SW¹⁾	2	1329		
125	5							279 SW¹⁾	2	1473		
Plugs with gland entry, in 16 - 63 A = IP 44 , in 125 A = IP 67  1)												
 215306SW	16	3	215 304 SW			215 306 SW				10	101	
	Plugs IP 44  with inverted cable entry											
 230SW	16	5						210 SW		10/60	176	
	32	5						230 SW		10/60	250	
Plugs IP 44 , with cable gland												

Consult customer service for other amperage and voltage ratings and configurations.

Female Connectors & Socket-Outlets IP 44 for Light & Stage Applications IEC/EN 60 309

  			Amperage	Poles	<div style="background-color: yellow; padding: 2px;"> 110 V 50 a. 60 Hz <small>3pole 4pole 5pole</small> <small>4h 4h 4h</small> </div>	<div style="background-color: blue; color: white; padding: 2px;"> 230 V 50 a. 60 Hz <small>3pole 4pole 5pole</small> <small>6h 9h 9h</small> </div>	<div style="background-color: red; color: white; padding: 2px;"> 400 V 50 a. 60 Hz <small>3pole 4pole 5pole</small> <small>9h 6h 6h</small> </div>	<div style="background-color: black; color: white; padding: 2px;"> 500 V 50 a. 60 Hz <small>3pole 4pole 5pole</small> <small>7h 7h 7h</small> </div>		
Part numbers										
	16	3				311 306 SW			10	147
	16	4					311 406 SW		10	197
	16	5					311 SW		10	214
	32	3				331 306 SW			10	265
	32	4					331 406 SW		10	278
	32	5					331 SW		10	300
	63	3				361 306 SW			5	656
	63	4					361 406 SW		5	771
	63	5					361 SW		5	787
125	3				379 306 SW²⁾			2	1362	
125	4					379 406 SW²⁾		2	1536	
125	5					379 SW²⁾		2	1710	
331306SW Couplers with gland entry, 16 - 63 A = IP 44 , 125 A = IP 67 ²⁾										
	16	3	315 304 SW			315 306 SW			10	140
	315306SW Couplers IP 44 , with inverted cable entry									
	16	5					310 SW		10/60	219
	32	5					330 SW		10/60	311
310SW Couplers IP 44 , with cable gland										
	16	3	410 304 SW			410 306 SW			10	128
	16	4					410 406 SW		10	106
	16	5					410 SW		10	165
	32	3				430 306 SW			10	208
	32	4					430 406 SW		10	215
	32	5					430 SW		10	226
	63	3				460 306 SW			5	586
	63	4					460 406 SW		5	645
	63	5					460 SW		5	776
125	3				479 306 SW³⁾			2	990	
125	4					479 406 SW³⁾		2	1155	
125	5					479 SW³⁾		2	1319	
430SW Panel sockets, straight, 16 - 63 A = IP 44 , 125 A = IP 67 ³⁾, fingerproof acc. to BGV A2										

Consult customer service for other amperage and voltage ratings and configurations.

SCREW-LESS IDC PLUGS AND CONNECTORS... ...BROUGHT TO YOU BY WALTHER ELECTRIC

CEEtyp™

CEEtyp plugs and connectors, with insulation displacement technology, are designed to increase productivity and lower the installed cost of wire termination. Utilization of the quick connection system for all wiring jobs, large and small, will speed and improve wire terminations while saving you money. Time and labor savings can be up to 60% when compared to other connection systems.

No wire stripping — the installation is fast and easy. The usual stripping procedure is not required. Simply remove outer cable jacket to length, fold over and position the conductors in the piercing pockets, and the connection is complete.

The Walther quick connection system provides an optimum electrical bond between the conductor and the piercing metal. Once the threaded grip ring is fastened onto the strain relief, the proper amount of force has been applied providing a uniform and controlled connection.

The insulation displacement connections are designed for wire sizes 18 — 14 AWG (1 — 2.5 mm²) for the 16-Amp versions and 14 — 10 AWG (2.5 mm² — 6 mm²) for the 32-Amp versions and are suitable for use under extreme conditions such as heavy vibration.

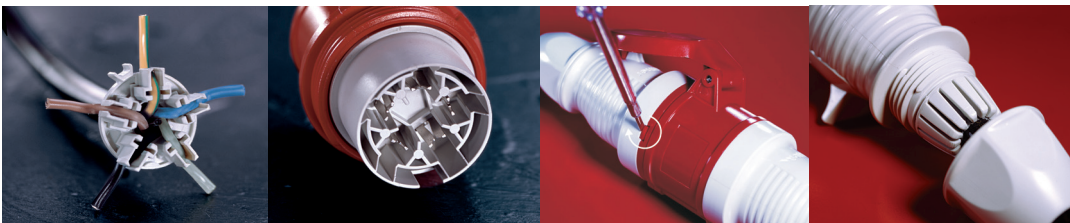



Distributor ring:
To accept
5 wires

IDC terminals:
Automatic connection gives
constant, permanent
contact pressure

Snap-fit back and
front:
totally secure -
only unlocks
with screwdriver

Automatic cable gland:
the absolutely safe
solution

ORDERING INFORMATION

				Male Plug	Female Connector
Amps	No. of Wires	Voltage AC	Clock Position of Ground Contact		
16	3P + N + G	400	6	210SL	310SL
32	3P + N + G	400	6	230SL	330SL

Consult customer service for other amperage and voltage ratings and configurations.



Remove approx. 35 - 40 mm of the sheathing from the cable (with 6 mm² 45 mm) and feed it through the back part from behind. Cut off the non-conductive core.



Then lead all five conductors through the distributor ring. Draw one after the other conductor sideways into the marked connection chambers. No stripping required.



Fit distributor ring onto front part. **Important:** Aligning nose provides for correct position when inserted in guide groove.



Fit back part onto front part and turn until parts lock in place automatically.



Finally tighten the cable gland (torque at least 4 Nm) - ready.



To disassemble first unscrew the cable gland (a). Then press the screwdriver (blade width 3.0 mm) deeply into the opening slot of the back part. Turn screwdriver clockwise to unlock the parts again.



Features & Benefits:

- 🔑 Solid Rubber enclosure is “non-conductive” for indoor or outdoor use
- 🔑 Compact, strong and portable easy-to-carry top handle
- 🔑 Units can be custom built to your exact specifications
- 🔑 Versatile design allows for multiple types of interconnects i.e. IEC 60309, CAMLOKS, stage pins, NEMA devices
- 🔑 Internal breaker or fuse protected under a transparent side-entry, hinged cover
- 🔑 Modular design allows for “multiple-tier” custom construction
- 🔑 Black color allowed for use in nuclear facilities
- 🔑 Durable thick-wall construction
- 🔑 UV resistant allows for use outdoors or in harsh environments

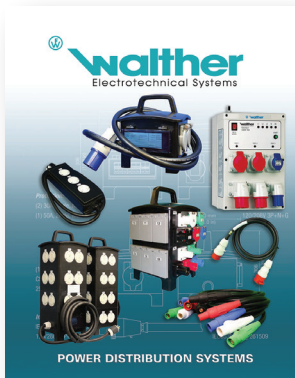

Check out full 40 page catalog online or ask for a printed copy today.



Example: Part Number 269419

2	6	9	4	19
Device Type 1st Digit	Amperage Rating 2nd Digit	Versions (Environmental) 3rd Digit	Poles and Wires 4th Digit	Clock Position 5th & 6th Digit
1= Female Socket-Outlet (Surface (Mount))	1= 20A North American 16A International	0= One top entry (splashproof) 1= Three entries (splashproof) 9=Three entries (Watertight)	3= 2 Pole + G or 1 Pole + N + G 4= 3 Pole + G or 2 Pole + N + G	1 Hour = 01 2 Hour = 02 3 Hour = 03 4 Hour = 04 5 Hour = 05 6 Hour = 06
2= Male Plug 3= Female Connector	6= 60A North American 63A International 7= 100A North American 125A International	0= With cable entry boot (splashproof) 1= With strain relief conn. (splashproof) 9= With strain relief conn. (Watertight)	5= 3 Pole + N + G 7= 6 Pole + G	7 Hour = 07 8 Hour = 08 9 Hour = 09 10 Hour = 10 11 Hour = 11 12 Hour = 12
4= Female Receptacle Socket-Outlet (Panel Mount Striaight)		0= Various mounting and 1= Flange sizes 2= (splashproof)		1 Hour = 13 2 Hour = 14 3 Hour = 15
5= Female Receptacle Socket-Outlet (Panel Mount Angled)		4= Two-Piece (spalshproof)		4 Hour = 16 5 Hour = 17 6 Hour = 18
		7= Various mounting and 8= flange sizes 9= (Watertight)		7 Hour = 19 8 Hour = 20 9 Hour = 21
6= Male Inlet (Appliance Plug)		0= Surface Mount Angled (splashproof) 1= Panel Mount Angled (splashproof) 5= Panel Mount Straight (splashproof) 6= Two-Piece (splashproof) 8= Surface Mount (Watertight) 9= Panel Mount (Watertight)		10 Hour = 22 11 Hour = 23 12 Hour = 24

TABLE 1 Cable and Conductor Strip Length

		Device Rating				
		North American	20A	30A	60A	100A
		International	16A	32A	63A	125A
Outer Jacket Strip Length	inch	2	2 1/2	3	4	
	mm	50	63	76	102	
Conductor Strip Length	inch	1/2	1/2	3/4	1 1/8	
	mm	12	12	19	28	
Pilot Conductor Strip Length	inch			7/16	5/8	
	mm			11	16	

TABLE 2 Maximum Torque applied to terminal screws

		Device Rating				
		North American	20A	30A	60A	100A
		International	16A	32A	63A	125A
Torque Terminal Screw	lb. - in.	7.1	7.1	17.6	35.3	
	N - m	0.8	0.8	2	4	
Torque Pilot Screw	lb. - in.			7.1	7.1	
	N - m			0.8	0.8	

TABLE 4 Metric and AWG/MCM conductor size equivalents

Conductor Size		Test Range (Amperage)
mm ²	AWG/MCM	
1,0	18	0-8
1,5	16	8-12
2,5	14	12-15
2,5	12	15-20
4,0	10	20-25
6,0	10	25-32
10	8	32-50
16	6	50-65
25	4	65-85
35	3	85-100
35	2	100-115
50	1	115-130
50	1/0	130-150
70	2/0	150-175
95	3/0	175-200
95	4/0	200-225
120	250	225-250
150	300	250-275
185	350	275-300
185	400	300-350
240	500	350-400

TABLE 3 Cable and Conductor Range

Amps		Poles and Wires	From		To		Cord Grip Range				
							With Cable Gland		With Cable Sleeve		
							North American	International	North American	International	
16	20	2P3W	16	S	10	S	inch	0.275 - 0.530	0.275 - 0.530	0.275 - 0.675	0.275 - 0.675
							mm	7 - 13.5	7 - 13.5	7 - 17	7 - 17
							inch	.395 - .825	0.275 - 0.630	0.315 - 0.800	0.315 - 0.800
							mm	10 - 21	7 - 16	8 - 20	8 - 20
							inch	.395 - .825	0.275 - 0.630	0.315 - 0.800	0.315 - 0.800
							mm	10 - 21	7 - 16	8 - 20	8 - 20
30	32	2P3W	12	S	8	S	inch	.395 - .825	.395 - .825	0.590 - 0.950	0.435 - 0.950
							mm	10 - 21	10 - 21	15 - 24	11 - 24
							inch	0.650 - 1.10	.395 - .825	0.590 - 0.950	0.435 - 0.950
							mm	16.5 - 28	10 - 21	15 - 24	11 - 24
							inch	0.650 - 1.10	.395 - .825	0.590 - 0.950	0.435 - 0.950
							mm	16.5 - 28	10 - 21	15 - 24	11 - 24
60*	63*	2P3W	8	S	4	S or W	inch	.650 - 1.50	.650 - 1.50	0.635 - 1.30	0.600 - 1.30
							mm	16.5 - 38	16.5 - 38	16 - 33	15 - 33
							inch	.650 - 1.50	.650 - 1.50	0.635 - 1.30	0.600 - 1.30
							mm	16.5 - 38	16.5 - 38	16 - 33	15 - 33
							inch	.650 - 1.50	.650 - 1.50	0.635 - 1.30	0.600 - 1.30
							mm	16.5 - 38	16.5 - 38	16 - 33	15 - 33
100*	125*	2P3W	6	S or W	2/0	S or W	inch	.950 - 1.90	.950 - 1.90		
							mm	24 - 48	24 - 48		
							inch	.950 - 1.90	.950 - 1.90		
							mm	24 - 48	24 - 48		
							inch	.950 - 1.90	.950 - 1.90		
							mm	24 - 48	24 - 48		

* Pilot conductor 16 to 8 AWG

WATERTIGHT PLUGS (IP67)

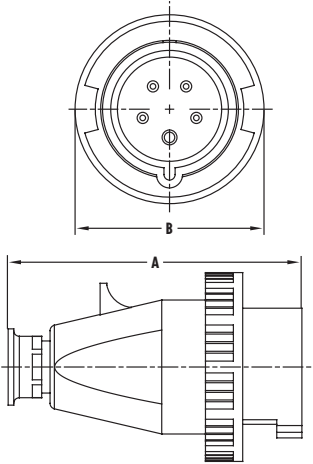

Amps		Type	Dimensions		Cord Grip Range		
N.A.	Intl.		A	B	N. American	International	
20	16	3 Wire	inch	4.96	2.83	0.275 - 0.530	0.275 - 0.530
			mm	126	72	7.0 - 13.5	7.0 - 13.5
20	16	4 Wire	inch	5.20	3.19	0.395 - 0.825	0.275 - 0.630
			mm	132	81	10.0 - 21.0	7.0 - 16.0
20	16	5 Wire	inch	5.20	3.46	0.395 - 0.825	0.275 - 0.630
			mm	132	88	10.0 - 21.0	7.0 - 16.0
30	32	3 Wire	inch	6.14	3.78	0.395 - 0.825	0.395 - 0.825
			mm	156	96	10.0 - 21.0	10.0 - 21.0
30	32	4 Wire	inch	6.14	3.78	0.650 - 1.10	0.395 - 0.825
			mm	156	96	16.5 - 28.0	10.0 - 21.0
30	32	5 Wire	inch	6.14	4.06	0.650 - 1.10	0.395 - 0.825
			mm	156	103	16.5 - 28.0	10.0 - 21.0
60	63	3, 4, & 5 Wire	inch	9.57	4.33	0.650 - 1.50	0.650 - 1.50
			mm	243	110	16.5 - 38.0	16.5 - 38.0
100	125	3, 4, & 5 Wire	inch	12.40	5.12	0.950 - 1.90	0.950 - 1.90
			mm	315	130	24.0 - 48.0	24.0 - 48.0

SPLASHPROOF PLUGS (IP44) (with cable gland)

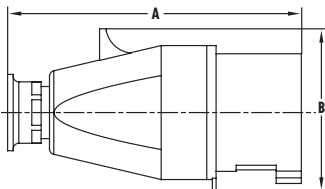

Amps		Type	Dimensions		Cord Grip Range		
N.A.	Intl.		A	B	N. American	International	
20	16	3 Wire	inch	4.84	2.36	0.275 - 0.530	0.275 - 0.530
			mm	123	60	7.0 - 13.5	7.0 - 13.5
20	16	4 Wire	inch	5.16	2.68	0.395 - 0.825	0.275 - 0.630
			mm	131	68	10.0 - 21.0	7.0 - 16.0
20	16	5 & 7 Wire	inch	5.16	2.95	0.395 - 0.825	0.275 - 0.630
			mm	131	75	10.0 - 21.0	7.0 - 16.0
30	32	3 Wire	inch	6.10	3.11	0.395 - 0.825	0.395 - 0.825
			mm	155	79	10.0 - 21.0	10.0 - 21.0
30	32	4 Wire	inch	6.10	3.11	0.650 - 1.10	0.395 - 0.825
			mm	155	79	16.5 - 28.0	10.0 - 21.0
30	32	5 & 7 Wire	inch	6.10	3.46	0.650 - 1.10	0.395 - 0.825
			mm	155	88	16.5 - 28.0	10.0 - 21.0
60	63	3, 4, & 5 Wire	inch	9.45	3.82	0.650 - 1.50	0.650 - 1.50
			mm	240	97	16.5 - 38.0	16.5 - 38.0

SPLASHPROOF PLUGS (IP44) (with cable sleeve)

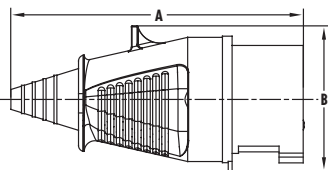

Amps		Type	Dimensions		Cord Grip Range		
N.A.	Intl.		A	B	N. American	International	
20	16	3 Wire	inch	5.63	2.36	0.275 - 0.675	0.275 - 0.675
			mm	143	60	7.0 - 17.0	7.0 - 17.0
20	16	4 Wire	inch	5.79	2.68	0.315 - 0.800	0.315 - 0.800
			mm	147	68	8.0 - 20.0	8.0 - 20.0
20	16	5 & 7 Wire	inch	6.02	2.95	0.315 - 0.800	0.315 - 0.800
			mm	153	75	8.0 - 20.0	8.0 - 20.0
30	32	3 Wire	inch	7.13	3.11	0.590 - 0.950	0.435 - 0.950
			mm	181	79	15.0 - 24.0	11.0 - 24.0
30	32	4 Wire	inch	7.13	3.11	0.590 - 0.950	0.435 - 0.95
			mm	181	79	15.0 - 24.0	11.0 - 24.0
30	32	5 & 7 Wire	inch	7.13	3.46	0.590 - 0.950	0.435 - 0.95
			mm	181	88	15.0 - 24.0	11.0 - 24.0
60	63	3, 4, & 5 Wire	inch	9.92	3.82	0.635 - 1.30	0.600 - 1.30
			mm	252	97	16.0 - 33.0	15.0 - 33.0

WATERTIGHT CONNECTORS (IP67)

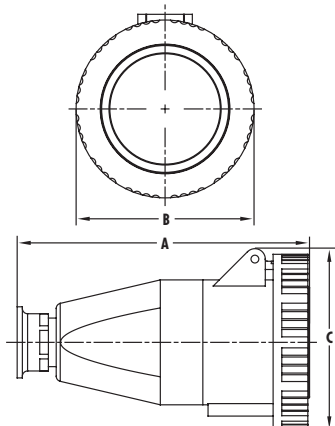

Amps		Type	Dimensions			Cord Grip Range		
N.A.	Intl.		A	B	C	N. American	International	
20	16	3 Wire	inch	5.35	2.83	3.07	0.275 - 0.530	0.275 - 0.530
			mm	136	72	78	7.0 - 13.5	7.0 - 13.5
20	16	4 Wire	inch	5.63	3.19	3.35	0.395 - 0.825	0.275 - 0.630
			mm	143	81	85	10.0 - 21.0	7.0 - 16.0
20	16	5 Wire	inch	5.63	3.46	3.58	0.395 - 0.825	0.275 - 0.630
			mm	143	88	91	10.0 - 21.0	7.0 - 16.0
30	32	3 Wire	inch	6.97	3.78	3.78	0.395 - 0.825	0.395 - 0.825
			mm	177	96	96	10.0 - 21.0	10.0 - 21.0
30	32	4 Wire	inch	6.97	3.78	3.78	0.650 - 1.10	0.395 - 0.825
			mm	177	96	96	16.5 - 28.0	10.0 - 21.0
30	32	5 Wire	inch	6.97	4.06	4.13	0.650 - 1.10	0.395 - 0.825
			mm	177	103	105	16.5 - 28.0	10.0 - 21.0
60	63	3, 4, & 5 Wire	inch	10.0	4.33	4.61	0.650 - 1.50	0.650 - 1.50
			mm	255	110	117	16.5 - 38.0	16.5 - 38.0
100	125	3, 4, & 5 Wire	inch	13.1	5.12	5.12	0.950 - 1.90	0.950 - 1.90
			mm	332	130	130	24.0 - 48.0	24.0 - 48.0

SPLASHPROOF CONNECTORS (IP44) (with cable gland)

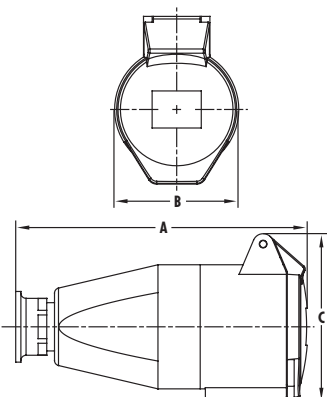

Amps		Type	Dimensions			Cord Grip Range		
N.A.	Intl.		A	B	C	N. American	International	
20	16	3 Wire	inch	5.32	2.01	2.68	0.275 - 0.530	0.275 - 0.530
			mm	135	51	68	7.0 - 13.5	7.0 - 13.5
20	16	4 Wire	inch	5.95	2.56	3.35	0.395 - 0.825	0.275 - 0.630
			mm	151	65	85	10.0 - 21.0	7.0 - 16.0
20	16	5 & 7 Wire	inch	5.95	2.56	3.35	0.395 - 0.825	0.275 - 0.630
			mm	151	65	85	10.0 - 21.0	7.0 - 16.0
30	32	3 Wire	inch	6.73	2.83	3.58	0.395 - 0.825	0.395 - 0.825
			mm	171	72	91	10.0 - 21.0	10.0 - 21.0
30	32	4 Wire	inch	6.73	2.83	3.58	0.650 - 1.10	0.395 - 0.825
			mm	171	72	91	16.5 - 28.0	10.0 - 21.0
30	32	5 & 7 Wire	inch	6.73	2.83	3.86	0.650 - 1.10	0.395 - 0.825
			mm	171	72	98	16.5 - 28.0	10.0 - 21.0
60	63	3, 4, & 5 Wire	inch	10.0	3.78	4.49	0.650 - 1.50	0.650 - 1.50
			mm	255	96	114	16.5 - 38.0	16.5 - 38.0

SPLASHPROOF CONNECTORS (IP44) (with cable sleeve)

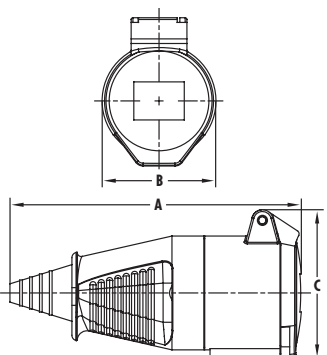

Amps		Type	Dimensions			Cord Grip Range		
N.A.	Intl.		A	B	C	N. American	International	
20	16	3 Wire	inch	6.06	2.01	2.69	0.275 - 0.675	0.275 - 0.675
			mm	154	51	68.4	7.0 - 17.0	7.0 - 17.0
20	16	4 Wire	inch	6.54	2.56	2.97	0.315 - 0.800	0.315 - 0.800
			mm	166	65	75.4	8.0 - 20.0	8.0 - 20.0
20	16	5 & 7 Wire	inch	6.54	2.56	3.29	0.315 - 0.800	0.315 - 0.800
			mm	166	65	83.5	8.0 - 20.0	8.0 - 20.0
30	32	3 Wire	inch	7.72	2.83	3.54	0.590 - 0.950	0.435 - 0.950
			mm	196	72	90	15.0 - 24.0	11.0 - 24.0
30	32	4 Wire	inch	7.72	2.83	3.54	0.590 - 0.950	0.435 - 0.95
			mm	196	72	90	15.0 - 24.0	11.0 - 24.0
30	32	5 & 7 Wire	inch	7.72	2.83	3.78	0.590 - 0.950	0.435 - 0.95
			mm	196	72	96	15.0 - 24.0	11.0 - 24.0
60	63	3, 4, & 5 Wire	inch	10.5	3.78	4.41	0.635 - 1.30	0.600 - 1.30
			mm	266	96	112	16.0 - 33.0	15.0 - 33.0

WATERTIGHT RECEPTACLE (IP67) (Straight)

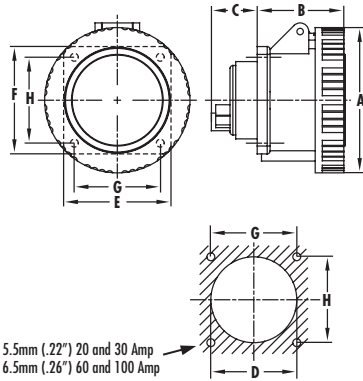

Amps	N.A.	Intl.	Type	Dimensions								
				A	B	C	D	E	F	G	H	
20	16		3 Wire	inch	2.82	2.05	1.10	1.81	2.44	2.44	1.85	1.85
				mm	71.5	52	28	46	62	62	47	47
20	16		4 Wire	inch	31.9	2.05	1.10	2.36	2.95	2.95	2.36	2.36
				mm	81	52	28	60	75	75	60	60
20	16		5 Wire	inch	3.46	2.05	1.10	2.36	2.95	2.95	2.36	2.36
				mm	88	52	28	60	75	75	60	60
30	32		3 & 4 Wire	inch	3.78	2.56	1.06	2.36	2.95	2.95	2.36	2.36
				mm	96	65	27	60	75	75	60	60
30	32		5 Wire	inch	4.06	2.56	1.06	2.36	2.95	2.95	2.36	2.36
				mm	103	65	27	60	75	75	60	60
60	63		3, 4, & 5 Wire	inch	4.29	3.27	2.05	3.54	3.94	4.21	3.03	3.35
				mm	109	83	52	90	100	107	77	85
100	125		3, 4, & 5 Wire	inch	5.12	3.78	2.52	3.54	4.49	4.49	3.54	3.54
				mm	130	96	64	90	114	114	90	90

WATERTIGHT RECEPTACLE (IP67) (Angled 15°)

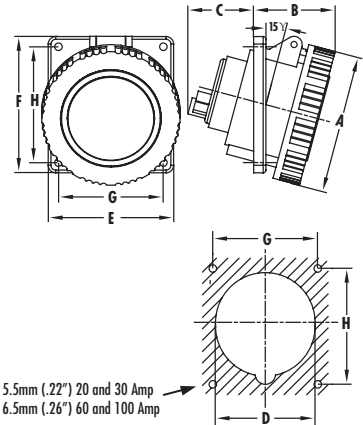

Amps	N.A.	Intl.	Type	Dimensions								
				A	B	C	D	E	F	G	H	
20	16		3 Wire	inch	2.82	1.93	1.61	2.01	2.44	2.68	1.85	1.85
				mm	71.5	49	41	51	62	68	47	47
20	16		4 Wire	inch	3.19	2.05	1.50	2.87	3.62	3.94	3.03	3.35
				mm	81	52	38	73	92	100	77	85
20	16		5 Wire	inch	3.46	2.05	1.50	2.87	3.62	3.94	3.03	3.35
				mm	88	52	38	73	92	100	77	85
30	32		3 & 4 Wire	inch	3.78	2.20	1.85	2.87	3.62	3.94	3.03	3.35
				mm	96	56	47	73	92	100	77	85
30	32		5 Wire	inch	4.06	2.36	1.85	2.87	3.62	3.94	3.03	3.35
				mm	103	60	47	73	92	100	77	85
60	63		3, 4, & 5 Wire	inch	4.29	3.23	2.52	3.19	3.94	4.21	3.03	3.35
				mm	109	82	64	81	100	107	77	85
100	125		3, 4, & 5 Wire	inch	5.12	3.70	2.95	3.54	4.49	4.49	3.54	3.54
				mm	130	94	75	90	114	114	90	90

WATERTIGHT RECEPTACLE (IP67) (Angled 80°)

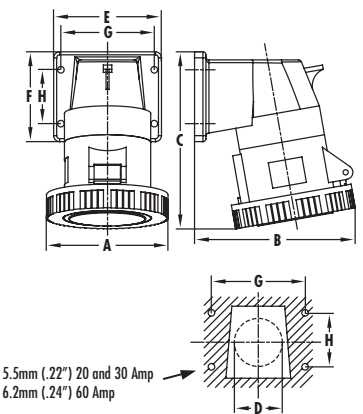

Amps	N.A.	Intl.	Type	Dimensions								
				A	B	C	D max	E	F	G	H	
20	16		3 Wire	inch	2.83	3.46	4.29	1.18	2.56	2.05	2.17	1.18
				mm	72	88	109	30	65	52	55	30
20	16		4 Wire	inch	3.19	4.25	4.84	1.50	3.15	2.60	2.68	1.57
				mm	81	108	123	38	80	66	68	40
20	16		5 Wire	inch	3.46	4.25	4.84	1.50	3.15	2.60	2.68	1.57
				mm	88	108	123	38	80	66	68	40
30	32		3 & 4 Wire	inch	3.78	4.76	5.71	1.73	3.54	2.95	3.07	1.77
				mm	96	121	145	44	90	75	78	45
30	32		5 Wire	inch	4.06	4.84	5.71	1.73	3.54	2.95	3.07	1.77
				mm	103	123	145	44	90	75	78	45
60	63		3, 4, & 5 Wire	inch	4.33	5.63	7.99	2.20	4.49	4.49	3.54	3.54
				mm	110	143	203	56	114	114	90	90

SPLASHPROOF RECEPTACLES (IP44) (Straight)

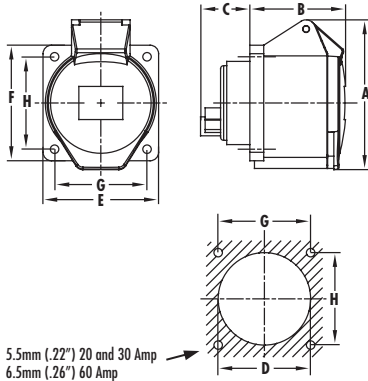

Amps			Dimensions								
N.A.	Intl.	Type	A	B	C	D	E	F	G	H	
20	16	3 Wire	inch	2.68	2.05	1.10	1.81	2.44	2.44	1.85	1.85
			mm	68	52	28	46	62	62	47	47
20	16	4 & 5 Wire	inch	3.35	2.09	1.10	2.36	2.95	2.95	2.36	2.36
			mm	85	53	28	60	75	75	60	60
20	16	7 Wire	inch	3.35	2.09	1.10	2.36	3.15	3.15	2.36	2.36
			mm	85	53	28	60	80	80	60	60
30	32	3 & 4 Wire	inch	3.58	2.56	1.06	2.36	2.95	2.95	2.36	2.36
			mm	91	65	27	60	75	75	60	60
30	32	5 Wire	inch	3.86	2.56	1.06	2.36	2.95	2.95	2.36	2.36
			mm	98	65	27	60	75	75	60	60
30	32	7 Wire	inch	3.86	2.56	1.06	2.36	3.15	3.15	2.36	2.36
			mm	98	65	27	60	80	80	60	60
60	63	3, 4, & 5 Wire	inch	4.49	3.35	2.05	3.54	3.94	4.21	3.03	3.35
			mm	114	85	52	90	100	107	77	85

SPLASHPROOF RECEPTACLE (IP44) (Angled 15°)

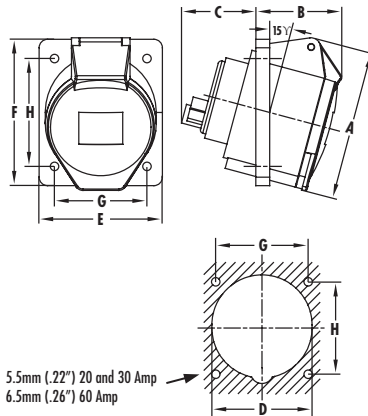

Amps			Dimensions								
N.A.	Intl.	Type	A	B	C	D	E	F	G	H	
20	16	3 Wire	inch	2.68	1.77	1.61	2.01	2.44	2.68	1.85	1.85
			mm	68	45	41	51	62	68	47	47
20	16	4 Wire	inch	3.35	2.01	1.50	2.36	2.95	2.95	2.36	2.36
			mm	85	51	38	60	75	75	60	60
20	16	5 Wire	inch	3.35	2.01	1.50	2.56	2.95	3.35	2.36	2.36
			mm	85	51	38	65	75	85	60	60
30	32	3 Wire	inch	3.58	2.05	1.85	2.64	2.95	3.54	2.36	2.36
			mm	91	52	47	67	75	90	60	60
30	32	4 Wire	inch	3.85	2.05	1.85	2.64	2.95	3.54	2.36	2.36
			mm	91	52	47	67	75	90	60	60
30	32	5 Wire	inch	3.86	2.20	1.85	2.70	3.15	3.74	2.36	2.36
			mm	98	56	47	68.5	80	95	60	60
60	63	3, 4, & 5 Wire	inch		3.11	2.52	3.19	3.94	4.21	3.03	3.35
			mm		79	64	81	100	107	77	85

SPLASHPROOF RECEPTACLE (IP44) (Angled 80°)

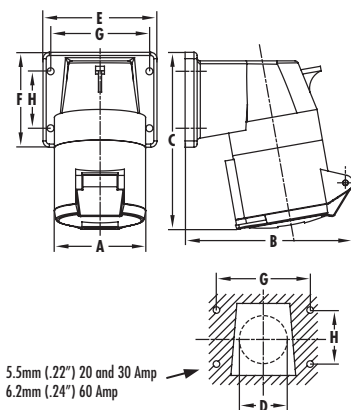

Amps			Dimensions								
N.A.	Intl.	Type	A	B	C	D max	E	F	G	H	
20	16	3 Wire	inch	2.01	3.43	4.57	1.18	2.56	2.05	2.17	1.18
			mm	51	87	116	30	65	52	55	30
20	16	4 Wire	inch	2.56	4.33	4.80	1.50	3.15	2.60	2.68	1.57
			mm	65	110	122	38	80	66	68	40
20	16	5 & 7 Wire	inch	2.56	4.33	4.80	1.50	3.15	2.60	2.68	1.57
			mm	65	110	122	38	80	66	68	40
30	32	3 Wire	inch	2.83	4.72	5.55	1.73	3.54	2.95	3.07	1.77
			mm	72	120	141	44	90	75	78	45
30	32	4 Wire	inch	2.83	4.72	5.55	1.73	3.54	2.95	3.07	1.77
			mm	72	120	141	44	90	75	78	45
30	32	5 & 7 Wire	inch	2.83	4.88	5.59	1.73	3.54	2.95	3.07	1.77
			mm	72	124	142	44	90	75	78	45
60	63	3, 4, & 5 Wire	inch	3.78	5.51	7.64	2.20	4.49	4.49	3.54	3.54
			mm	96	140	194	56	114	114	90	90

WATERTIGHT INLETS (IP67) (Straight)

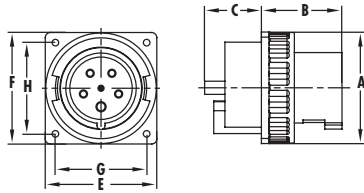

6.5mm (.26") 60 and 100 Amp

Amps		Type	Dimensions									
N.A.	Intl.		A	B	C	D	E	F	G	H		
100	125	3 Wire	inch	5.12	3.70	2.20	3.54	5.12	5.12	4.09	4.09	
			mm	130	94	56	90	130	130	104	104	
100	125	4 Wire	inch	5.12	3.70	2.20	3.54	5.12	5.12	4.09	4.09	
			mm	130	94	56	90	130	130	104	104	
100	125	5 Wire	inch	5.12	3.70	2.20	3.54	5.12	5.12	4.09	4.09	
			mm	130	94	56	90	130	130	104	104	

WATERTIGHT INLETS (IP67) (Angled 80°)

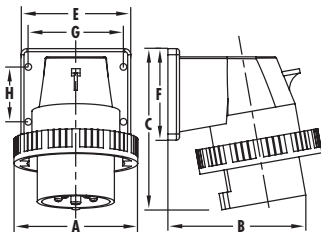

5.5mm (.22") 20 and 30 Amp
6.2mm (.24") 60 and 100 Amp

Amps		Type	Dimensions								
N.A.	Intl.		A	B	C	D (max)	E	F	G	H	
20	16	3 Wire	inch	2.83	3.19	3.86	1.18	2.56	2.05	2.17	1.18
			mm	72	81	98	30	65	52	55	30
20	16	4 Wire	inch	3.19	3.90	4.33	1.50	3.15	2.60	2.68	1.57
			mm	81	99	110	38	80	66	68	40
20	16	5 Wire	inch	3.50	4.06	4.45	1.50	3.15	2.60	2.68	1.57
			mm	89	103	113	38	80	66	68	40
30	32	3 Wire	inch	3.78	4.45	5.12	1.73	3.54	2.95	3.07	1.77
			mm	96	113	130	44	90	75	78	45
30	32	4 Wire	inch	3.78	4.45	5.12	1.73	3.54	2.95	3.07	1.77
			mm	96	113	130	44	90	75	78	45
30	32	5 Wire	inch	4.02	4.61	5.12	1.73	3.54	2.95	3.07	1.77
			mm	102	117	130	44	90	75	78	45
60	63	3, 4, & 5 Wire	inch	4.33	5.00	7.20	2.20	4.49	4.49	3.54	3.54
			mm	110	127	183	56	114	114	90	90

WATERTIGHT INLETS (IP67) (Surface Mount, Angled 80°)

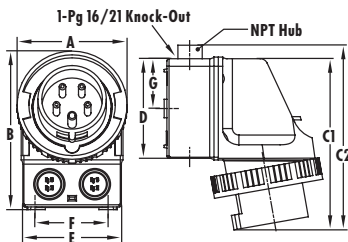

Amps		Type	Dimensions								Hub Size*	
N.A.	Intl.		A	B	C ¹	C ²	D	E	F	G		
20	16	3 Wire	inch	2.83	5.51	6.06	6.73	3.78	3.74	2.62	1.87	3/4"
			mm	72	140	154	171	96	95	66.5	47.5	
20	16	4 Wire	inch	3.19	5.51	6.06	6.73	3.78	3.74	2.62	1.87	3/4"
			mm	81	140	154	171	96	95	66.5	47.5	
20	16	5 Wire	inch	3.46	5.51	6.06	6.73	3.78	3.74	2.62	1.87	3/4"
			mm	88	140	154	171	96	95	66.5	47.5	
30	32	3 Wire	inch	3.78	5.79	6.46	7.13	3.78	3.74	2.62	1.87	3/4"
			mm	96	147	164	181	96	95	66.5	47.5	
30	32	4 Wire	inch	3.78	5.79	6.46	7.13	3.78	3.74	2.62	1.87	3/4"
			mm	96	147	164	181	96	95	66.5	47.5	
30	32	5 Wire	inch	4.06	5.91	6.46	7.13	3.78	3.74	2.62	1.87	3/4"
			mm	103	150	164	181	96	95	66.5	47.5	

SPLASHPROOF INLETS (IP44) (Straight)

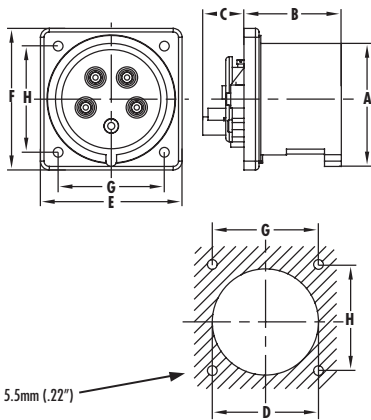

Amps			Dimensions								
N.A.	Intl.	Type	A	B	C	D	E	F	G	H	
20	16	3 Wire	inch	1.85	1.85	0.87	1.97	2.44	2.44	1.85	1.85
			mm	47	47	22	50	62	62	47	47
20	16	4 Wire	inch	2.09	1.85	0.87	2.64	3.15	3.15	2.36	2.36
			mm	53	47	22	67	80	80	60	60
20	16	5 & 7 Wire	inch	2.40	1.85	0.87	2.64	3.15	3.15	2.36	2.36
			mm	61	47	22	67	80	80	60	60
30	32	3 Wire	inch	2.48	2.20	0.87	2.80	3.15	3.15	2.36	2.36
			mm	63	56	22	71	80	80	60	60
30	32	4 Wire	inch	2.48	2.20	0.87	2.80	3.15	3.15	2.36	2.36
			mm	63	56	22	71	80	80	60	60
30	32	5 & 7 Wire	inch	2.72	2.20	0.87	2.80	3.15	3.15	2.36	2.36
			mm	69	56	22	71	80	80	60	60
60	63	5 Wire	inch	2.99	3.27	1.14	3.39	4.17	4.33	3.54	3.54
			mm	76	83	29	86	106	110	90	90

SPLASHPROOF INLETS (IP44) (Angled 80°)

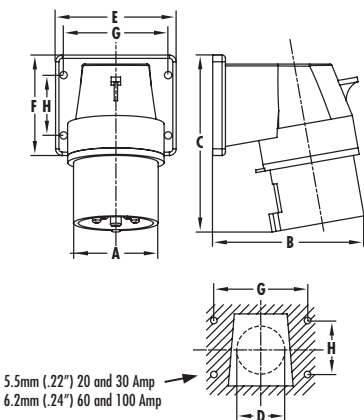

Amps			Dimensions								
N.A.	Intl.	Type	A	B	C	D (max)	E	F	G	H	
20	16	3 Wire	inch	1.71	2.83	3.82	1.18	2.56	2.05	2.17	1.18
			mm	43.5	72	97	30	65	52	55	30
20	16	4 Wire	inch	1.97	3.54	4.33	1.50	3.15	2.60	2.68	1.57
			mm	50	90	110	38	80	66	68	40
20	16	5 & 7 Wire	inch	2.20	3.62	4.33	1.50	3.15	2.60	2.68	1.57
			mm	56	92	110	38	80	66	68	40
30	32	3 Wire	inch	2.24	4.06	5.08	1.73	3.54	2.95	3.07	1.77
			mm	57	103	129	44	90	75	78	45
30	32	4 Wire	inch	2.24	4.06	5.08	1.73	3.54	2.95	3.07	1.77
			mm	57	103	129	44	90	75	78	45
30	32	5 & 7 Wire	inch	2.52	4.06	5.08	1.73	3.54	2.95	3.07	1.77
			mm	64	103	129	44	90	75	78	45
60	63	3, 4, & 5 Wire	inch	2.72	4.57	7.28	2.20	4.49	4.49	3.54	3.54
			mm	69	116	185	56	114	114	90	90

SPLASHPROOF INLETS (IP44) (Surface Mount, Angled 80°)

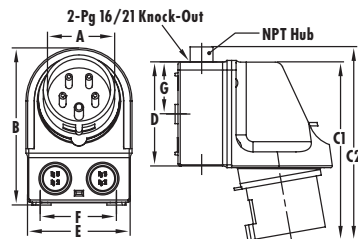

Amps			Dimensions								Hub Size*	
N.A.	Intl.	Type	A	B	C ¹	C ²	D	E	F	G		
20	16	4 Wire	inch	1.97	5.51	5.95	6.61	3.78	3.74	2.62	1.87	3/4"
			mm	50	140	151	168	96	95	66.5	47.5	
20	16	5 & 7 Wire	inch	2.20	5.51	5.95	6.61	3.78	3.74	2.62	1.87	3/4"
			mm	56	140	151	168	96	95	66.5	47.5	
30	32	3 Wire	inch	2.24	5.51	6.30	6.97	3.78	3.74	2.62	1.87	3/4"
			mm	57	140	160	177	96	95	66.5	47.5	
30	32	4 Wire	inch	2.24	5.51	6.30	6.97	3.78	3.74	2.62	1.87	3/4"
			mm	57	140	160	177	96	95	66.5	47.5	
30	32	5 & 7 Wire	inch	2.52	5.51	6.30	6.97	3.78	3.74	2.62	1.87	3/4"
			mm	64	140	160	177	96	95	66.5	47.5	

WATERTIGHT RECEPTACLES (IP67) (Surface Mount, Angled 80°)

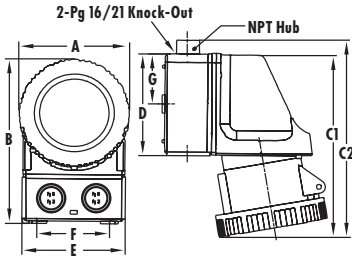

Amps N.A.	Intl.	Type	Dimensions								Hub Size*	
			A	B	C ¹	C ²	D	E	F	G		
20	16	3 Wire	inch	2.83	5.51	6.46	7.13	3.78	3.74	2.62	1.87	3/4"
			mm	72	140	164	181	96	95	66.5	47.5	
		4 Wire	inch	3.19	5.67	6.46	7.13	3.78	3.74	2.62	1.87	3/4"
			mm	81	144	164	181	96	95	66.5	47.5	
		5 Wire	inch	3.46	5.79	6.46	7.13	3.78	3.74	2.62	1.87	3/4"
			mm	88	147	164	181	96	95	66.5	47.5	
30	32	3 Wire	inch	3.78	6.06	6.93	7.60	3.78	3.74	2.62	1.87	3/4"
			mm	96	154	176	193	96	95	66.5	47.5	
		4 Wire	inch	3.78	6.06	6.93	7.60	3.78	3.74	2.62	1.87	3/4"
			mm	96	154	176	193	96	95	66.5	47.5	
		5 Wire	inch	4.06	6.14	6.93	7.60	3.78	3.74	2.62	1.87	3/4"
			mm	103	156	176	193	96	95	66.5	47.5	

WATERTIGHT RECEPTACLES (IP67) (Surface Mount, Angled 80°)

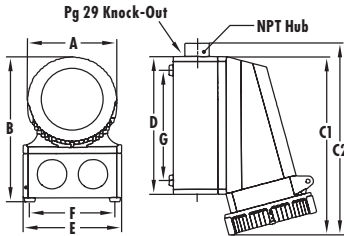

Amps N.A.	Intl.	Type	Dimensions								Hub Size*	
			A	B	C ¹	C ²	D	E	F	G		
60	63	4 Wire	inch	4.33	7.01	8.82	9.76	6.77	4.76	4.09	5.35	1 1/4"
			mm	110	178	224	248	172	121	104	136	
		5 Wire	inch	4.33	7.01	8.82	9.76	6.77	4.76	4.09	5.35	1 1/4"
			mm	110	178	224	248	172	121	104	136	

WATERTIGHT RECEPTACLES (IP67) (Surface Mount, Angled 80°)

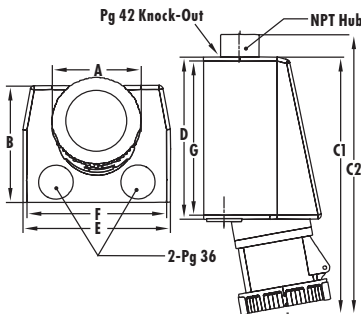

Amps N.A.	Intl.	Type	Dimensions								Hub Size*	
			A	B	C ¹	C ²	D	E	F	G		
100	125	3 Wire	inch	5.12	7.48	16.0	16.9	10.4	8.66	7.87	9.45	2"
			mm	130	190	406	430	263	220	200	240	
		4 Wire	inch	5.12	7.48	16.0	16.9	10.4	8.66	7.87	9.45	2"
			mm	130	190	406	430	263	220	200	240	
		5 Wire	inch	5.12	7.48	16.0	16.9	10.4	8.66	7.87	9.45	2"
			mm	130	190	406	430	263	220	200	240	

SPLASHPROOF RECEPTACLES (IP44) (Surface Mount, Angled 80°)

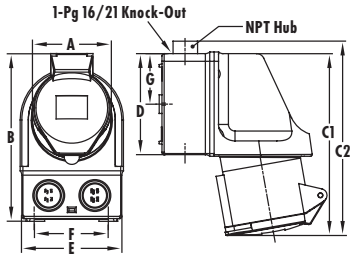

Amps		Type	Dimensions								Hub Size*	
N.A.	Intl.		A	B	C ¹	C ²	D	E	F	G		
20	16	3 Wire	inch	2.01	5.51	6.30	6.97	3.78	3.74	2.62	1.87	3/4"
			mm	51	140	160	177	96	95	66.5	47.5	
20	16	4 Wire	inch	2.56	5.63	6.46	7.13	3.78	3.74	2.62	1.87	3/4"
			mm	65	143	164	181	96	95	66.5	47.5	
20	16	5 & 7 Wire	inch	2.56	5.75	6.46	7.13	3.78	3.74	2.62	1.87	3/4"
			mm	65	146	164	181	96	95	66.5	47.5	
30	32	3 Wire	inch	2.83	6.06	6.81	7.48	3.78	3.74	2.62	1.87	3/4"
			mm	72	154	173	190	96	95	66.5	47.5	
30	32	4 Wire	inch	2.83	6.06	6.81	7.48	3.78	3.74	2.62	1.87	3/4"
			mm	72	154	173	190	96	95	66.5	47.5	
30	32	5 & 7 Wire	inch	2.83	6.18	6.81	7.48	3.78	3.74	2.62	1.87	3/4"
			mm	72	157	173	190	96	95	66.5	47.5	

SPLASHPROOF RECEPTACLES (IP44) (Surface Mount, Angled 80°)

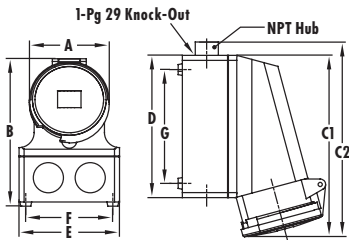

Amps		Type	Dimensions								Hub Size*	
N.A.	Intl.		A	B	C ¹	C ²	D	E	F	G		
60	63	4 Wire	inch	3.78	7.01	8.66	9.61	6.77	4.76	4.09	5.35	1 1/4"
			mm	96	178	220	244	172	121	104	136	
60	63	5 Wire	inch	3.78	7.01	8.66	9.61	6.77	4.76	4.09	5.35	1 1/4"
			mm	96	178	220	244	172	121	104	136	



Need a specific print? Call us, we can help!

WATERTIGHT INLET (IP67) (Surface Mount, Angled 80°)

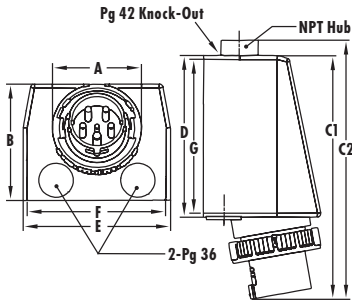

Amps		Type	Dimensions								Hub Size*	
N.A.	Intl.		A	B	C ¹	C ²	D	E	F	G		
60	63	3 Wire	inch	4.33	4.65	9.13	10.1	5.98	4.65	4.17	4.72	1 1/4"
			mm	110	118	232	256	152	118	106	120	
60	63	4 Wire	inch	4.33	4.65	9.13	10.1	5.98	4.65	4.17	4.72	1 1/4"
			mm	110	118	232	256	152	118	106	120	
60	63	5 Wire	inch	4.33	4.65	9.13	10.1	5.98	4.65	4.17	4.72	1 1/4"
			mm	110	118	232	256	152	118	106	120	
100	125	3 Wire	inch	5.12	6.89	15.4	16.3	10.4	8.66	7.87	9.45	2"
			mm	130	175	390	414	263	220	200	240	
100	125	4 Wire	inch	5.12	6.89	15.4	16.3	10.4	8.66	7.87	9.45	2"
			mm	130	175	390	414	263	220	200	240	
100	125	5 Wire	inch	5.12	6.89	15.4	16.3	10.4	8.66	7.87	9.45	2"
			mm	130	175	390	414	263	220	200	240	

Note: Two (2) PG36 knock-outs are on the bottom of the 100/125 amp device only.

SPLASHPROOF INLET (IP44) (Surface Mount, Angled 80°)

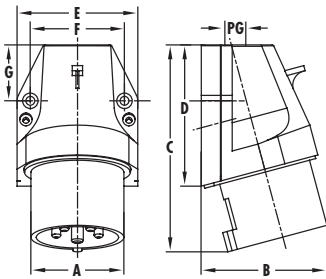

Amps		Type	Dimensions							
N.A.	Intl.		A	B	C	D	E	F	G	PG
16	3 Wire	inch	1.71	2.36	4.33	2.91	2.36	1.79	1.10	
		mm	43.5	60	110	74	60	45.5	28	13.5
16	4 Wire	inch	1.97	2.87	4.61	3.15	2.91	2.36	1.22	
		mm	50	73	117	80	74	60	31	16
16	5 & 7 Wire	inch	2.20	2.87	4.61	3.15	2.91	2.36	1.22	
		mm	56	73	117	80	74	60	31	16
32	3 Wire	inch	2.24	3.15	5.55	3.82	3.23	2.36	1.77	
		mm	57	80	141	97	82	60	45	21
32	4 Wire	inch	2.24	3.15	5.55	3.82	3.23	2.36	1.77	
		mm	57	80	141	97	82	60	45	21
32	5 & 7 Wire	inch	2.52	3.39	5.55	3.82	3.23	2.36	1.77	
		mm	64	86	141	97	82	60	45	21

SPLASHPROOF RECEPTACLE (IP44) (Surface Mount, Angled 80°)

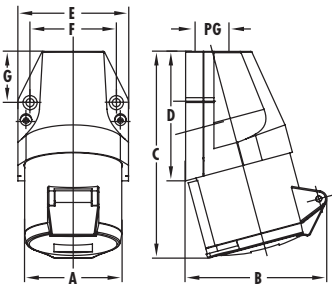

Amps		Type	Dimensions							
N.A.	Intl.		A	B	C	D	E	F	G	PG
16	3 Wire	inch	2.68	2.95	4.72	2.91	2.36	1.79	1.10	
		mm	68	75	120	74	60	45.5	28	13.5
16	4 Wire	inch	3.35	3.39	5.04	3.15	2.91	2.36	1.22	
		mm	85	86	128	80	74	60	31	16
16	5 & 7 Wire	inch	3.35	3.54	5.08	3.15	2.91	2.36	1.22	
		mm	85	90	129	80	74	60	31	16
32	3 Wire	inch	3.58	4.06	6.06	3.82	3.23	2.36	1.77	
		mm	91	103	154	97	82	60	45	21
32	4 Wire	inch	3.58	4.06	6.06	3.82	3.23	2.36	1.77	
		mm	91	103	154	97	82	60	45	21
32	5 & 7 Wire	inch	3.86	4.13	6.10	3.82	3.23	2.36	1.77	
		mm	98	105	155	97	82	60	45	21

SPLASHPROOF PLUG (IP44) (Angled)

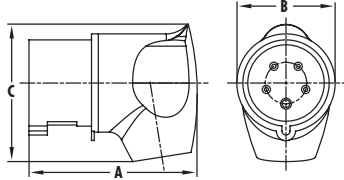

Amps		Type	Dimensions			Cord Grip Range	
N.A.	Intl.		A	B	C		
20	16	3 Wire	inch	3.31	1.98	2.66	0.315 - 0.590 8.0 - 15.0
			mm	84	50.3	67.5	
20	16	4 Wire	inch	3.98	2.53	3.32	0.395 - 0.650 10.0 - 16.5
			mm	101	64.3	84.2	
20	16	5 Wire	inch	3.98	2.53	3.39	0.395 - 0.650 10.0 - 16.5
			mm	101	64.3	86	
30	32	3 Wire	inch	4.53	2.83	3.76	0.435 - 0.865 11.0 - 22.0
			mm	115	72	95.5	
30	32	4 Wire	inch	4.53	2.83	3.76	0.435 - 0.865 11.0 - 22.0
			mm	115	72	95.5	
30	32	5 Wire	inch	4.53	2.83	3.96	0.435 - 0.865 11.0 - 22.0
			mm	115	72	100.5	

SPLASHPROOF CONNECTOR (IP44) (Angled)

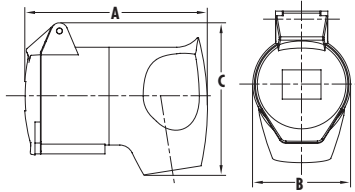

Amps		Type	Dimensions			Cord Grip Range	
N.A.	Intl.		A	B	C		
20	16	3 Wire	inch	3.74	1.98	3.15	0.315 - 0.510 8.0 - 13.0
			mm	95	50.3	80	



Precision manufacturing aided by C.N.C. technology.



SAFETY

Designed to combine a disconnect switch and a receptacle into one compact device. Walther's mechanical interlock receptacles eliminate the possibility of making or breaking the circuit under load or making a haphazard connection.

A mechanism within the enclosure prevents the switch from being turned to the "ON" position until the plug is fully engaged into the receptacle. Once inserted, the plug is locked in place when the switch is turned on and can't be removed until the switch is turned to the "OFF" position. This prevents making or breaking the circuit under load.

The integration of the switch and the receptacle in a single, compact enclosure encourages the safe operating practice of disconnecting at the switch rather than the plug and receptacle.

The nonmetallic enclosure, while abuse and corrosion resistant, is also non conductive, which enhances the safety of the product. The device can be connected to metallic conduit without interfering with the ground continuity. All mechanical interlock receptacles provide lockout protection for greater safety and comply with OSHA Lockout/Tagout requirements.

RELIABILITY

These horsepower rated devices are available in both splashproof and watertight versions.

NEMA 4X Watertight (IP67) devices are designed for the most demanding environments and provide protection against corrosion, dirt, dust, splashing water and hose-directed water.

Splashproof (IP44) devices provide many of the heavy-duty construction features found in the watertight devices, but at a more economical cost. These units are suitable and recommended for use in a variety of light industrial environments and provide protection against damaging deposits of dirt and dust, rain and splashing water.

Watertight and splashproof devices provide exceptional UV stability for superior outdoor performance.

WORLDWIDE INTERCHANGEABILITY

Walther's mechanical interlock receptacles are built to IEC60309-1 and 309-2 specifications and are completely compatible with not only Walther IEC60309-2 plugs, but with any manufacturer's plugs that conform to these IEC standards and color coding system... anywhere in the world.



Walther Mechanical Interlocks, with built-in circuit breakers, incorporate an interlocking receptacle with MCB Type "C" circuit breakers in a non-metallic enclosure that meets Type 4X (Washdown, Corrosion Resistant) requirements.

This new design combines the circuit breakers, switch and receptacle in a single enclosure. The Type "C" circuit breakers are mounted on DIN rail directly above the switch.

Walther CIRCUIT-BREAKER Mechanical Interlocks

The new CIRCUIT-BREAKER Mechanical Interlock integrates a circuit breaker (which takes the place of a switch) and receptacle in a nonmetallic enclosure that meets Type 4X (Washdown, Corrosion Resistant) requirements.

- Switched, Circuit Breaker Interlock Receptacles are available in 20, 30, 60 and 100 Amp (North American Ratings) and 16, 32, 63 and 125 Amp (International Ratings).
- UL489 Listed 22KAIC protection.



IEC60309-1 and 309-2 MECHANICAL INTERLOCKS

Compliance with OSHA Lockout Requirements

Walther's Mechanical Interlock's bright red handle can be locked in the "OFF" position as a method of compliance with OSHA lockout requirements. The handle can accept up to a 5/16" padlock shaft.

Watertight NEMA 4X, 12K Enclosure

Walther's Mechanical Interlocks are gasketed and rated as a Watertight NEMA 4X, 12K enclosure. The nonmetallic enclosure, while abuse and corrosion resistant, is also non-conductive which enhances the safety of the product.

Grounding Plate

Walther's Mechanical Interlocks are supplied with a free floating grounding plate. Because of this unique method of grounding, conduit entry may be made from the top, bottom or side. No other brand offers this type of installation versatility.



Compact Size

All versions and sizes are designed to fit within the web of an 8" column. This compact size allows the use of columns as a mounting location.

Easy Identification

Catalog number, rating and certifications are indicated on the label for easy identification of mating devices.

Color Coded Receptacle Covers

Receptacle covers are color-coded by voltage in accordance with IEC60309 standard.

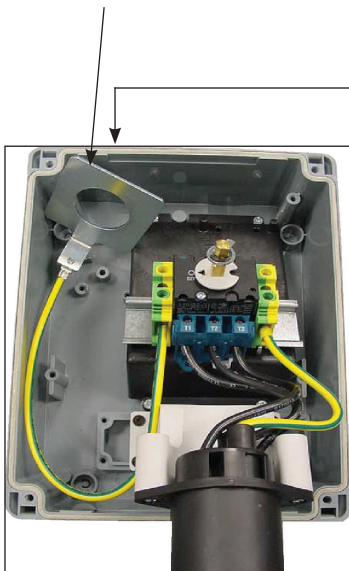

A Pre-Molded Offset Dimple

Walther does not install a hub at the top of our mechanical interlocks, rather a pre-molded offset dimple (drill point) is provided instead of a conduit entry hole. This allows the installer to choose the size of the conduit to be used, and the location where the conduit will be attached to the enclosure (top, bottom or side entry) without the use of knockout plugs and reducers. Arranging the conduit entry hole at the dimple location will prevent condensation from falling directly on the interior electrical components, such as the switch. It will also allow for more room to pull conductors when wiring. Approximately 40% of all entry is from the bottom.



Completely Compatible

Completely compatible with not only Walther IEC60309-1 and 309-2 plugs, but with any manufacturer's plugs that conform to the IEC60309 standards and color coding system...anywhere in the world. When Walther IP67 plugs are used in-conjunction with NEMA 4X rated Walther mechanical interlocks, both devices are NEMA 4X rated.

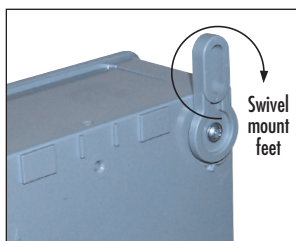

Swivel Mount Feet (135°)

Swivel mount feet can be used for installations where irregular or tight fit applications exist.

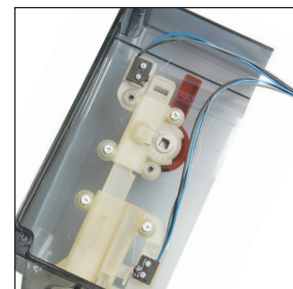

Micro Switch

Available upon request. May be used to transmit signal when plug is inserted or when switch is turned to the "ON" position. May also be used for indicator light to display and confirm when switch is turned "ON" or "OFF". Consult technical service for price and delivery.



20, 30, 60 Amp
NEMA 4X Watertight (IP67)
Drawing A
(See Drawing on Page 55)



20, 30, 60 Amp
Splashproof (IP44)
Drawing A
(See Drawing on Page 55)

Amps	Poles and Wires	Voltage AC	Clock Position of Ground Contact	Horsepower Ratings	NEMA 4X Watertight (IP67)	Splashproof (IP44)
20	2P3W	120	4	0.75	AE119316	AE110316
		240	6	2	AE119318	AE110318
		480	7	4	AE119319	AE110319
	3P4W	120/240	12	.75 @ 120V 2 @ 240V	AE119424	AE110424
		3Ø240	9	5	AE119421	AE110421
		3Ø480	7	10	AE119419	AE110419
		3Ø600	5	14	AE119417	AE110417
		3ØY120/208	9	5	AE119521	AE110521
		3ØY277/480	7	10	AE119519	AE110519
30	2P3W	120	4	1.5	AE139316	AE130316
		240	6	3.5	AE139318	AE130318
		480	7	6	AE139319	AE130319
	3P4W	120/240	12	1.5 @ 120 3.5 @ 240	AE139424	AE130424
		3Ø240	9	7.5	AE139421	AE130421
		3Ø480	7	15	AE139419	AE130419
		3Ø600	5	20	AE139417	AE130417
		3ØY120/208	9	7.5	AE139521	AE130521
		3ØY277/480	7	15	AE139519	AE130519
32*	3P4W	380 50Hz	3	12	AE139415	
		440 60Hz				
60	2P3W	120	4	3.5	AE169316	AE160316
		240	6	7.5	AE169318	AE160318
		480	7	13.5	AE169319	AE160319
	3P4W	120/240	12	3.5 @ 120 7.5 @ 240	AE169424	AE160424
		3Ø240	9	15	AE169421	AE160421
		3Ø480	7	28	AE169419	AE160419
		3Ø600	5	35	AE169417	AE160417
		3ØY120/208	9	15	AE169521	AE160521
		3ØY277/480	7	28	AE169519	AE160419
	4P5W	3ØY347/600	5	35	AE169517	AE160517

* 32 Amp. Only for Refrigerated Containers.



100 Amp
NEMA 4X Watertight (IP67)
Drawing B
(See Drawing on Page 55)

100	2P3W	120	4	7.5	A0189316		
		240	6	14	A0189318		
		480	7	28	A0189319		
	3P4W	120/240	12	7.5 @ 120 14 @ 240	A0189424		
		3Ø240	9	30	A0189421		
		3Ø480	7	60	A0189419		
		3Ø600	5	75	A0189417		
		4P5W	3ØY120/208	9	30	A0189521	
			3ØY277/480	7	60	A0189519	
	3ØY347/600		5	75	A0189517		



20, 30, 60 Amp
NEMA 4X Watertight (IP67)
Drawing C



20, 30, 60 Amp
Splashproof (IP44)
Drawing C

Amps	Poles and Wires	MCB	Voltage AC	Clock Position of Ground Contact	Horsepower Ratings	NEMA 4X Watertight (IP67)	Splashproof (IP44)
20	2P3W	1 Pole "C"	120	4	0.75	AL119316UD	AL110316UD
			240	6	2	AL119318UD	AL110318UD
			480	7	4	AL119319UD	AL110319UD
	3P4W	3 Pole "C"	120/240	12	.75 @ 120V 2 @ 240V	AL119424SA	AL110424SA
			3Ø240	9	5	AL119421SA	AL110421SA
			3Ø480	7	10	AL119419SA	AL110419SA
			3Ø600	5	14	AL119417SA	AL110417SA
			3ØY120/208	9	5	AL119521TA	AL110521TA
	4P5W	3 Pole "C"	3ØY277/480	7	10	AL119519TA	AL110519TA
3ØY347/600			5	14	AL119517TA	AL110517TA	
30	2P3W	1 Pole "C"	120	4	1.5	AL139316UD	AL130316UD
			240	6	3.5	AL139318UD	AL130318UD
			480	7	6	AL139319UD	AL130319UD
	3P4W	3 Pole "C"	120/240	12	1.5 @ 120 3.5 @ 240	AL139424SA	AL130424SA
			3Ø240	9	7.5	AL139421SA	AL130421SA
			3Ø480	7	15	AL139419SA	AL130419SA
			3Ø600	5	20	AL139417SA	AL130417SA
			3ØY120/208	9	7.5	AL139521TA	AL130521TA
	4P5W	3 Pole "C"	3ØY277/480	7	15	AL139519TA	AL130519TA
3ØY347/600			5	20	AL139517TA	AL130517TA	
32*	3P4W	3 Pole "C"	380 50Hz 440 60Hz	3	12	AL139415SA	
60	2P3W	1 Pole "C"	120	4	3.5	AL169316UD	AL160316UD
			240	6	7.5	AL169318UD	AL160318UD
			480	7	13.5	AL169319UD	AL160319UD
	3P4W	3 Pole "C"	120/240	12	3.5 @ 120 7.5 @ 240	AL169424SA	AL160424SA
			3Ø240	9	15	AL169421SA	AL160421SA
			3Ø480	7	28	AL169419SA	AL160419SA
			3Ø600	5	35	AL169417SA	AL160417SA
			3ØY120/208	9	15	AL169521TA	AL160521TA
	4P5W	3 Pole "C"	3ØY277/480	7	28	AL169519TA	AL160419TA
3ØY347/600			5	35	AL169517TA	AL160517TA	

* 32 Amp. Only for Refrigerated Containers.

Dimensions

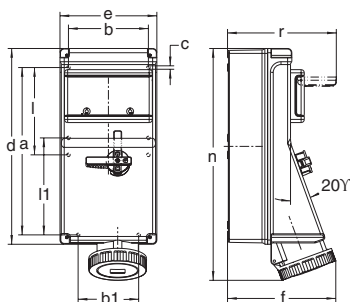

Drawing C

Amps	N.A.	Int'l	Poles and Wires	Unit of Measure	Dimensions												
					a	b	b1	c	d	e	f	g	h	i	l1	n	r
20	16	2P3W	inch	12.44	5.94	4.49	0.26	14.57	7.20	7.17	7.60	6.50	7.20	15.79	15.91	8.11	
			mm	316	151	114	6.5	370	183	182	193	165	183	401	404	206	
20	16	3P4W	inch	12.44	5.94	4.49	0.26	14.57	7.20	7.36	7.64	6.50	7.20	15.91	15.94	8.11	
			mm	316	151	114	6.5	370	183	187	194	165	183	404	405	206	
20	16	4P5W	inch	12.44	5.94	4.49	0.26	14.57	7.20	7.24	7.72	6.50	7.20	15.94	16.14	8.11	
			mm	316	151	114	6.5	370	183	184	196	165	183	405	410	206	
30	32	2P3W	inch	12.44	5.94	4.49	0.26	14.57	7.20	7.36	7.91	6.50	7.20	16.34	16.46	8.11	
			mm	316	151	114	6.5	370	183	187	201	165	183	415	418	206	
30	32	3P4W	inch	12.44	5.94	4.49	0.26	14.57	7.20	7.36	7.91	6.50	7.20	16.34	16.46	8.11	
			mm	316	151	114	6.5	370	183	187	201	165	183	415	418	206	
30	32	4P5W	inch	12.44	5.94	4.49	0.26	14.57	7.20	7.44	7.91	6.50	7.20	16.42	16.46	8.11	
			mm	316	151	114	6.5	370	183	189	201	165	183	417	418	206	
60	63	2P3W	inch	12.44	5.94	4.49	0.26	14.57	7.20	7.72	8.23	6.50	7.20	17.01	17.44	8.11	
			mm	316	151	114	6.5	370	183	196	209	165	183	432	443	206	
60	63	3P4W	inch	12.44	5.94	4.49	0.26	14.57	7.20	7.72	8.23	6.50	7.20	17.01	17.44	8.11	
			mm	316	151	114	6.5	370	183	196	209	165	183	432	443	206	
60	63	4P5W	inch	12.44	5.94	4.49	0.26	14.57	7.20	7.72	8.23	6.50	7.20	17.01	17.44	8.11	
			mm	316	151	114	6.5	370	183	196	209	165	183	432	443	206	



20, 30 Amp
NEMA 4X Watertight (IP67)
Drawing D



20, 30 Amp
Splashproof (IP44)
Drawing D

Amps	Poles and Wires	Voltage AC	Clock Position of Ground Contact	Horsepower Ratings	NEMA 4X Watertight (IP67)	Splashproof (IP44)	
20	2P3W	120	4	0.75	AT119316	AT110316	
		240	6	2	AT119318	AT110318	
		480	7	4	AT119319	AT110319	
	3P4W	120/240	12	.75 @ 120V 2 @ 240V	AT119424	AT110424	
		3Ø240	9	5	AT119421	AT110421	
		3Ø480	7	10	AT119419	AT110419	
		3Ø600	5	14	AT119417	AT110417	
		4P5W	3ØY120/208	9	5	AT119521	AT110521
			3ØY277/480	7	10	AT119519	AT110519
3ØY347/600	5		14	AT119517	AT110517		
30	2P3W	120	4	1.5	AT139316	AT130316	
		240	6	3.5	AT139318	AT130318	
		480	7	6	AT139319	AT130319	
	3P4W	120/240	12	1.5 @ 120 3.5 @ 240	AT139424	AT130424	
		3Ø240	9	7.5	AT139421	AT130421	
		3Ø480	7	15	AT139419	AT130419	
		3Ø600	5	20	AT139417	AT130417	
	4P5W	3ØY120/208	9	7.5	AT139521	AT130521	
		3ØY277/480	7	15	AT139519	AT130519	
3ØY347/600		5	20	AT139517	AT130517		
32*	3P4W	380 50Hz 440 60Hz	3	12	AT139415		

* 32 Amp. Only for Refrigerated Containers.

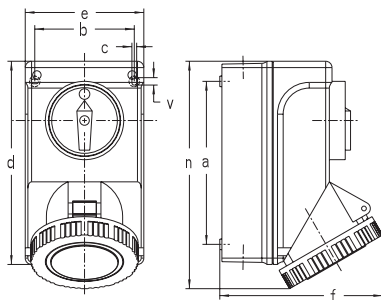

Drawing D

Dimensions

Amps		Poles and Wires	Unit of Measure	Dimensions							IP44		NEMA 4X IP67		IP44		NEMA 4X IP67	
N.A.	Int'l			a	b	c	d	e	f	f	n	n	v					
20	16	2P3W	inch	5.00	3.07	0.18	6.54	3.82	4.57	4.72	7.28	7.28	0.28					
			mm	127	78	4.5	166	97	116	120	185	185	7					
20	16	3P4W	inch	5.00	3.07	0.18	6.54	3.82	4.72	4.92	7.28	7.28	0.28					
			mm	127	78	4.5	166	97	120	125	185	185	7					
20	16	4P5W	inch	5.00	3.07	0.18	6.54	3.82	4.92	5.20	7.28	7.28	0.28					
			Mm	127	78	4.5	166	97	125	132	185	185	7					
30	32	2P3W	inch	6.06	3.70	0.18	7.60	4.45	5.71	6.06	8.46	8.46	0.28					
			mm	154	94	4.5	193	113	145	154	215	215	7					
30	32	3P4W	inch	6.06	3.70	0.18	7.60	4.45	5.71	6.06	8.46	8.46	0.28					
			mm	154	94	4.5	193	113	145	154	215	215	7					
30	32	4P5W	inch	6.06	3.70	0.18	7.60	4.45	5.83	6.06	8.46	8.46	0.28					
			mm	154	94	4.5	193	113	148	154	215	215	7					



20, 30 Amp
NEMA 4X Watertight (IP67)
Drawing E



20, 30 Amp
Splashproof (IP44)
Drawing E

Amps	Poles and Wires	MCB	Voltage AC	Clock Position of Ground Contact	Horsepower Ratings	NEMA 4X Watertight (IP67)	Splashproof (IP44)
20	2P3W	1 Pole "C"	120	4	0.75	AU119316UD	AU110316UD
			240	6	2	AU119318UD	AU110318UD
			480	7	6	AU119319UD	AU110319UD
	3P4W	3 Pole "C"	120/240	12	.75 @ 120V 2 @ 240V	AU119424SA	AU110424SA
			3Ø240	9	5	AU119421SA	AU110421SA
			3Ø480	7	10	AU119419SA	AU810419SA
			3Ø600	5	14	AU119417SA	AU110417SA
	4P5W	3 Pole "C"	3ØY120/208	9	5	AU119521TA	AU110521TA
			3ØY277/480	7	10	AU119519TA	AU110519TA
3ØY347/600			5	14	AU119517TA	AU110517TA	
30	2P3W	1 Pole "C"	120	4	1.5	AU139316UD	AU130316UD
			240	6	3.5	AU139318UD	AU130318UD
			480	7	6	AU139319UD	AU130319UD
	3P4W	3 Pole "C"	120/240	12	1.5 @ 120 3.5 @ 240	AU139424SA	AU130424SA
			3Ø240	9	7.5	AU139421SA	AU130421SA
			3Ø480	7	15	AU139419SA	AU130419SA
			3Ø600	5	20	AU139417SA	AU130417SA
	4P5W	3 Pole "C"	3ØY120/208	9	7.5	AU139521TA	AU130521TA
			3ØY277/480	7	15	AU139519TA	AU130519TA
3ØY347/600			5	20	AU139517TA	AU130517TA	
32*	3P4W	3 Pole "C"	380 50Hz 440 60Hz	3	12	AU139415SA	

* 32 Amp. Only for Refrigerated Containers.

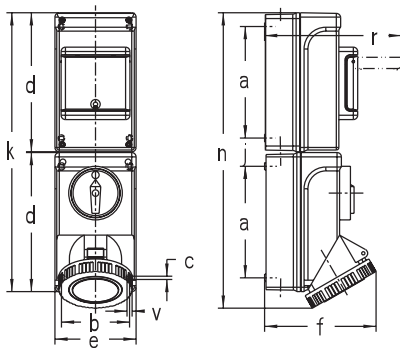

Drawing E

Dimensions

Amps	Poles and Wires		Unit of Measure	Dimensions															
	N.A.	Int'l		a	b	c	d	e	f	IP44	NEMA 4X IP67	j	k	IP44	NEMA 4X IP67	r	v		
20	16	2P3W	inch	5.00	3.07	0.18	6.54	3.82	4.57	4.72	1.54	13.11	13.86	13.86	6.97	0.28			
			mm	127	78	4.5	166	97	116	120	39	333	352	352	177	7			
20	16	3P4W	inch	5.00	3.07	0.18	6.54	3.82	4.72	4.92	1.54	13.11	13.86	13.86	6.97	0.28			
			mm	127	78	4.5	166	97	120	125	39	333	352	352	177	7			
20	16	4P5W	inch	5.00	3.07	0.18	6.54	3.82	4.92	5.20	1.54	13.11	13.86	13.86	6.97	0.28			
			mm	127	78	4.5	166	97	125	132	39	333	352	352	177	7			
30	32	2P3W	inch	6.06	3.70	0.18	7.60	4.45	5.71	6.06	1.54	15.24	16.10	16.10	7.52	0.28			
			mm	154	94	4.5	193	113	145	154	39	387	409	409	191	7			
30	32	3P4W	inch	6.06	3.70	0.18	7.60	4.45	5.71	6.06	1.54	15.24	16.10	16.10	7.52	0.28			
			mm	154	94	4.5	193	113	145	154	39	387	409	409	191	7			
30	32	4P5W	inch	6.06	3.70	0.18	7.60	4.45	5.83	6.06	1.54	15.24	16.10	16.10	7.52	0.28			
			mm	154	94	4.5	193	113	148	154	39	387	409	409	191	7			



20, 30, 60, 100 Amp
NEMA 4X Watertight (IP67)
Drawing B
(See Drawing on Page 55)



20, 30, 60 Amp
Splashproof (IP44)
Drawing A
(See Drawing on Page 55)

Amps	Poles and Wires	Voltage AC	Clock Position of Ground Contact	NEMA 4X Watertight (IP67)	Splashproof (IP44)
20	2P3W	120	4	AJ119316SH	AJ110316SH
		240	6	AJ119318SH	AJ110318SH
		480	7	AJ119319SH	AJ110319SH
	3P4W	120/240	12	AJ119424SH	AJ110424SH
		3Ø240	9	AJ119421SH	AJ110421SH
		3Ø480	7	AJ119419SH	AJ110419SH
	4P5W	3ØY120/208	9	AJ119521SH	AJ110521SH
		3ØY277/480	7	AJ119519SH	AJ110519SH
	30	2P3W	120	4	AJ139316SH
240			6	AJ139318SH	AJ130318SH
480			7	AJ139319SH	AJ130319SH
3P4W		120/240	12	AJ139424SH	AJ130424SH
		3Ø240	9	AJ139421SH	AJ130421SH
		3Ø480	7	AJ139419SH	AJ130419SH
4P5W		3ØY120/208	9	AJ139521SH	AJ130521SH
		3ØY277/480	7	AJ139519SH	AJ130519SH
32*		3P4W	380 50Hz 440 60Hz	3	AJ139415SH
60	2P3W	120	4	AJ169316SH	AJ160316SH
		240	6	AJ169318SH	AJ160318SH
		480	7	AJ169319SH	AJ160319SH
	3P4W	120/240	12	AJ169424SH	AJ160424SH
		3Ø240	9	AJ169421SH	AJ160421SH
		3Ø480	7	AJ169419SH	AJ160419SH
	4P5W	3ØY120/208	9	AJ169521SH	AJ160521SH
		3ØY277/480	7	AJ169519SH	AJ160519SH
	100	2P3W	120	4	A0189316SH
240			6	A0189318SH	
480			7	A0189319SH	
3P4W		120/240	12	A0189424SH	
		3Ø240	9	A0189421SH	
		3Ø480	7	A0189419SH	
4P5W		3ØY120/208	9	A0189521SH	
		3ØY277/480	7	A0189519SH	

* 32 Amp. Only for Refrigerated Containers.



IEC 309
CIRCUIT BREAKER VERSION

ELECTRICAL

Dielectric Voltage Withstand	3,000 Volts
Maximum Working Voltage	600 Volts RMS (switch version) 480 Volts RMS (circuit breaker version)
Current Interrupting	Certified for current interrupting at full rated current and voltage.
Short Circuit Withstand Rating	Suitable for use on a circuit capable of delivering not more than 10,000 RMS symmetrical amperes at the voltage rating of the receptacle.
Operations	Mechanical: 10,000 cycles Electrical: 6,000 cycles

MECHANICAL

Impact Resistance	In accordance with UL 746C
Terminal Identification	In accordance with UL, CSA and international conventions.
Product Identification	Identification, ratings and color code in accordance with UL, CSA and IEC requirements.
Lockout/Tagout	“ON” and “OFF” lockout/tagout capability at switch handle. Complies with OSHA Reg. 29CFR 1910.147
Mounting	
Switch Version	Internal or external adjustable mounting feet
Compact Version	Internal mounting
Circuit Breaker Version	Internal or external adjustable mounting feet

Minimum test requirements

ENVIRONMENTAL

Moisture Resistance	Watertight IP67 (Washdown) - UL Type 4X Splashproof IP44
Flammability	UL94-5VA & V0 Classifications
Operating Temperatures	Maximum Continuous: 60°C (140°F) Minimum Continuous: -40°C (-40°F)
UV Resistance	UV stabilized material
Chemicals	Resists most standard industrial hydrocarbons, acids, bases and solvents.

MATERIALS

Enclosure (all exterior components)	UL94-5VA/V0, UV stabilized, impact modified Valox®.
Contact Carrier	Molded arc resistant UL94-V0 thermoplastic
Gaskets	Neoprene or EPDM
Contacts (NEMA 4X, Watertight IP67)	Brass, Nickel Plated
Contacts (Splashproof IP44)	Brass
Hardware (screws & springs)	Steel with zinc-plated blue chromate or nickel plating.

APPROVALS & COMPLIANCES

UL 508 (switch version) Motor Disconnect
UL 508 (compact version) Manual Motor Controller
UL 231 & UL 489 (circuit breaker version)
UL1682 & 1686
CSA C22.2 No. 14, 182.1
IEC60309-1 & IEC60309-2

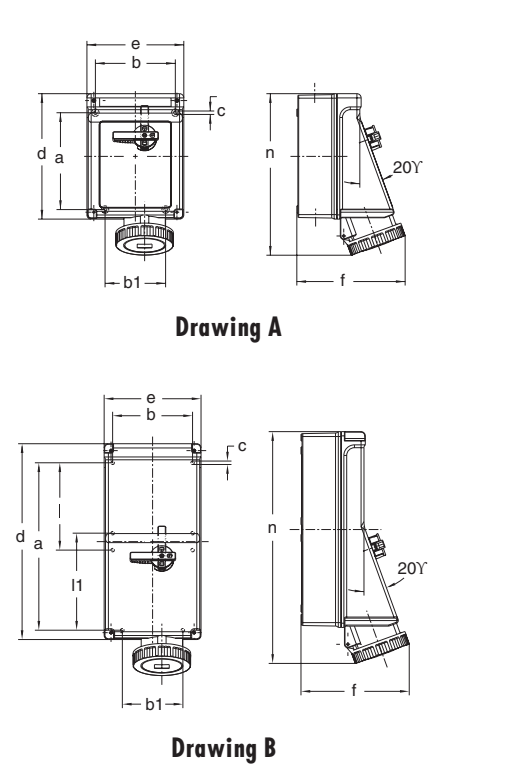

Drawing A

Amps		Poles and Wires	Unit of Measure	Dimensions										
N.A.	Int'l			a	b	b1	c	d	e	f	f	n	n	
20	16	2P3W	inch	7.20	5.94	4.49	0.26	9.33	7.20	7.17	7.60	10.55	10.63	
			mm	183	151	114	6.5	237	183	182	193	268	270	
20	16	3P4W	inch	7.20	5.94	4.49	0.26	9.33	7.20	7.36	7.64	10.63	10.71	
			mm	183	151	114	6.5	237	183	187	194	270	272	
20	16	4P5W	inch	7.20	5.94	4.49	0.26	9.33	7.20	7.24	7.72	10.75	10.91	
			mm	183	151	114	6.5	237	183	184	196	273	277	
30	32	2P3W	inch	7.20	5.94	4.49	0.26	9.33	7.20	7.36	7.91	11.10	11.22	
			mm	183	151	114	6.5	237	183	187	201	282	285	
30	32	3P4W	inch	7.20	5.94	4.49	0.26	9.33	7.20	7.36	7.91	11.10	11.22	
			mm	183	151	114	6.5	237	183	187	201	282	285	
30	32	4P5W	inch	7.20	5.94	4.49	0.26	9.33	7.20	7.44	7.91	11.18	11.38	
			mm	183	151	114	6.5	237	183	189	201	284	289	
60	63	2P3W	inch	7.20	5.94	4.49	0.26	9.33	7.20	7.72	8.23	11.89	12.17	
			mm	183	151	114	6.5	237	183	196	209	302	309	
60	63	3P4W	inch	7.20	5.94	4.49	0.26	9.33	7.20	7.72	8.23	11.89	12.17	
			mm	183	151	114	6.5	237	183	196	209	302	309	
60	63	4P5W	inch	7.20	5.94	4.49	0.26	9.33	7.20	7.72	8.23	11.89	12.17	
			mm	183	151	114	6.5	237	183	196	209	302	309	

Drawing B

Amps		Poles and Wires	Unit of Measure	Dimensions										
N.A.	Int'l			a	b	b1	c	d	e	f	n			
100	125	2P3W	inch	12.44	5.94	4.96	0.26	14.57	7.20	9.57	17.72			
			mm	316	151	126	6.5	370	183	243	450			
100	125	3P4W	inch	12.44	5.94	4.96	0.26	14.57	7.20	9.57	17.72			
			mm	316	151	126	6.5	370	183	243	450			
100	125	4P5W	inch	12.44	5.94	4.96	0.26	14.57	7.20	9.57	17.72			
			mm	316	151	126	6.5	370	183	243	450			



16, 32, 63 Amp
Watertight (IP67)
Drawing A
(See Drawing on Page 55)



16, 32, 63 Amp
Splashproof (IP44)
Drawing A
(See Drawing on Page 55)

Amps	Poles and Wires	Voltage AC	Clock Position of Ground Contact	NEMA 4X Watertight (IP67)	Splashproof (IP44)
16	2P3W	110	4	AE119304	AE110304
		230	6	AE119306	AE110306
		400	9	AE119309	AE110309
	3P4W	110	4	AE119404	AE110404
		230	9	AE119409	AE110409
		400	6	AE119406	AE110406
		500	7	AE119407	AE110407
		400	6	AE119	AE110
	4P5W	110	4	AE119504	AE110504
		230	9	AE119509	AE110509
		400	6	AE119	AE110
	32	2P3W	110	4	AE139304
230			6	AE139306	AE130306
400			9	AE139309	AE130309
3P4W		110	4	AE139404	AE130404
		230	9	AE139409	AE130409
		400	6	AE139406	AE130406
		500	7	AE139407	AE130407
		400	6	AE139	AE130
4P5W		110	4	AE139504	AE130504
		230	9	AE139509	AE130509
		400	6	AE139	AE130
32*		3P4W	380 50Hz 440 60Hz	3	AE139403
63	2P3W	110	4	AE169304	AE160304
		230	6	AE169306	AE160306
		400	9	AE169309	AE160309
	3P4W	110	4	AE169404	AE160404
		230	9	AE169409	AE160409
		400	6	AE169406	AE160406
		500	7	AE169407	AE160407
		400	6	AE169	AE160
	4P5W	110	4	AE169504	AE160504
		230	9	AE169509	AE160509
		400	6	AE169	AE160

* 32 Amp. Only for Refrigerated Containers.



125 Amp
Watertight (IP67)
Drawing B
(See Drawing on Page 55)

125	2P3W	110	4	A0179304	
		230	6	A0179306	
		400	9	A0179309	
	3P4W	110	4	A0179404	
		230	9	A0179409	
		400	6	A0179406	
		500	7	A0179407	
		400	6	A0179	
	4P5W	110	4	A0179504	
		230	9	A0179509	
		400	6	A0179	



16, 32, 63 Amp
Watertight (IP67)
Drawing C



16, 32, 63 Amp
Splashproof (IP44)
Drawing C

Amps	Poles and Wires	MCB	Voltage AC	Clock Position of Ground Contact	NEMA 4X Watertight (IP67)	Splashproof (IP44)
16	2P3W	1 Pole "C"	110	4	AL119304UD	AL110304UD
			230	6	AL119306UD	AL110306UD
			400	9	AL119309UD	AL110309UD
	3P4W	3 Pole "C"	110	4	AL119404SA	AL110404SA
			230	9	AL119409SA	AL110409SA
			400	6	AL119406SA	AL110406SA
			500	7	AL119407SA	AL110407SA
	4P5W	3 Pole "C"	110	4	AL119504TA	AL110504TA
			230	9	AL119509TA	AL110509TA
400			6	AL119TA	AL110TA	
32	2P3W	1 Pole "C"	110	4	AL139304UD	AL130304UD
			230	6	AL139306UD	AL130306UD
			400	9	AL139309UD	AL130309UD
	3P4W	3 Pole "C"	110	4	AL139404SA	AL130404SA
			230	9	AL139409SA	AL130409SA
			400	6	AL139406SA	AL130406SA
			500	7	AL139407SA	AL130407SA
	4P5W	3 Pole "C"	110	4	AL139504TA	AL130504TA
			230	9	AL139509TA	AL130509TA
400			6	AL139TA	AL130TA	
32*	3P4W	3 Pole "C"	380 50Hz 440 60Hz	3	AL139403SA	
63	2P3W	1 Pole "C"	110	4	AL169304UD	AL160304UD
			230	6	AL169306UD	AL160306UD
			400	9	AL169309UD	AL160309UD
	3P4W	3 Pole "C"	110	4	AL169404SA	AL160404SA
			230	9	AL169409SA	AL160409SA
			400	6	AL169406SA	AL160406SA
			500	7	AL169407SA	AL160407SA
	4P5W	3 Pole "C"	110	4	AL169504TA	AL160504TA
			230	9	AL169509TA	AL160509TA
400			6	AL169TA	AL160TA	

* 32 Amp. Only for Refrigerated Containers.

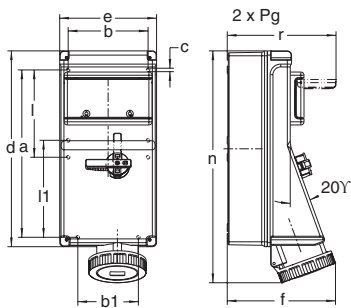

Drawing C

Dimensions

Amps	N.A.	Int'l	Poles and Wires	Unit of Measure	Dimensions															
					a	b	b1	c	d	e	f	IP44	IP67	l	ll	IP44	NEMA 4X IP67	n	r	
20	16	2P3W	inch	12.44	5.94	4.49	0.26	14.57	7.20	7.17	7.60	6.50	7.20	15.79	15.91	8.11				
			mm	316	151	114	6.5	370	183	182	193	165	183	401	404	206				
20	16	3P4W	inch	12.44	5.94	4.49	0.26	14.57	7.20	7.36	7.64	6.50	7.20	15.91	15.94	8.11				
			mm	316	151	114	6.5	370	183	187	194	165	183	404	405	206				
20	16	4P5W	inch	12.44	5.94	4.49	0.26	14.57	7.20	7.24	7.72	6.50	7.20	15.94	16.14	8.11				
			mm	316	151	114	6.5	370	183	184	196	165	183	405	410	206				
30	32	2P3W	inch	12.44	5.94	4.49	0.26	14.57	7.20	7.36	7.91	6.50	7.20	16.34	16.46	8.11				
			mm	316	151	114	6.5	370	183	187	201	165	183	415	418	206				
30	32	3P4W	inch	12.44	5.94	4.49	0.26	14.57	7.20	7.36	7.91	6.50	7.20	16.34	16.46	8.11				
			mm	316	151	114	6.5	370	183	187	201	165	183	415	418	206				
30	32	4P5W	inch	12.44	5.94	4.49	0.26	14.57	7.20	7.44	7.91	6.50	7.20	16.42	16.46	8.11				
			mm	316	151	114	6.5	370	183	189	201	165	183	417	418	206				
60	63	2P3W	inch	12.44	5.94	4.49	0.26	14.57	7.20	7.72	8.23	6.50	7.20	17.01	17.44	8.11				
			mm	316	151	114	6.5	370	183	196	209	165	183	432	443	206				
60	63	3P4W	inch	12.44	5.94	4.49	0.26	14.57	7.20	7.72	8.23	6.50	7.20	17.01	17.44	8.11				
			mm	316	151	114	6.5	370	183	196	209	165	183	432	443	206				
60	63	4P5W	inch	12.44	5.94	4.49	0.26	14.57	7.20	7.72	8.23	6.50	7.20	17.01	17.44	8.11				
			mm	316	151	114	6.5	370	183	196	209	165	183	432	443	206				



16, 32 Amp
Watertight (IP67)
Drawing D



16, 32 Amp
Splashproof (IP44)
Drawing D

Amps	Poles and Wires	Voltage AC	Position of Ground Contact	Clock		
				NEMA 4X Watertight (IP67)	Splashproof (IP44)	
16	2P3W	110	4	AT119304	AT110304	
		230	6	AT119306	AT110306	
		400	9	AT119309	AT110309	
	3P4W	110	4	AT119404	AT110404	
		230	9	AT119409	AT110409	
		400	6	AT119406	AT110406	
		500	7	AT119407	AT110407	
	4P5W	110	4	AT119504	AT110504	
		230	9	AT119509	AT110509	
		400	6	AT119	AT110	
	32	2P3W	110	4	AT139304	AT130304
			230	6	AT139306	AT130306
400			9	AT139309	AT130309	
3P4W		110	4	AT139404	AT130404	
		230	9	AT139409	AT130409	
		400	6	AT139406	AT130406	
		500	7	AT139407	AT130407	
4P5W		110	4	AT139504	AT130504	
		230	9	AT139509	AT130509	
		400	6	AT139	AT130	
32*		3P4W	380 50Hz 440 60Hz	3	AT139403	

* 32 Amp. Only for Refrigerated Containers.

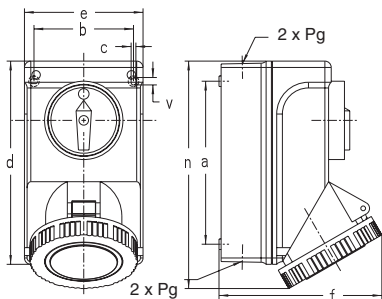

Drawing D

Dimensions

Amps	Poles and Wires	Unit of Measure	Dimensions													
			a	b	c	d	e	f	IP44	IP67	NEMA 4X IP44	NEMA 4X IP67	v			
N.A.	Int'l															
20	16	2P3W	inch	5.00	3.07	0.18	6.54	3.82	4.57	4.72	7.28	7.28	0.28			
			mm	127	78	4.5	166	97	116	120	185	185	7			
20	16	3P4W	inch	5.00	3.07	0.18	6.54	3.82	4.72	4.92	7.28	7.28	0.28			
			mm	127	78	4.5	166	97	120	125	185	185	7			
20	16	4P5W	inch	5.00	3.07	0.18	6.54	3.82	4.92	5.20	7.28	7.28	0.28			
			mm	127	78	4.5	166	97	125	132	185	185	7			
30	32	2P3W	inch	6.06	3.70	0.18	7.60	4.45	5.71	6.06	8.46	8.46	0.28			
			mm	154	94	4.5	193	113	145	154	215	215	7			
30	32	3P4W	inch	6.06	3.70	0.18	7.60	4.45	5.71	6.06	8.46	8.46	0.28			
			mm	154	94	4.5	193	113	145	154	215	215	7			
30	32	4P5W	inch	6.06	3.70	0.18	7.60	4.45	5.83	6.06	8.46	8.46	0.28			
			mm	154	94	4.5	193	113	148	154	215	215	7			



16, 32 Amp
Watertight (IP67)
Drawing E



16, 32 Amp
Splashproof (IP44)
Drawing E

Amps	Poles and Wires	MCB	Voltage AC	Clock Position of Ground Contact	NEMA 4X Watertight (IP67)	Splashproof (IP44)	
16	2P3W	1 Pole "C"	110	4	AU119304UD	AU110304UD	
			230	6	AU119306UD	AU110306UD	
			400	9	AU119309UD	AU110309UD	
	3P4W	3 Pole "C"	110	4	AU119404SA	AU110404SA	
			230	6	AU119406SA	AU110406SA	
			400	9	AU119409SA	AU810409SA	
			500	7	AU119407SA	AU110407SA	
	4P5W	3 Pole "C"	110	4	AU119504TA	AU110504TA	
			230	9	AU119509TA	AU110509TA	
400			6	AU119TA	AU110TA		
32	2P3W	1 Pole "C"	110	4	AU139304UD	AU130304UD	
			230	6	AU139306UD	AU130306UD	
			400	9	AU139309UD	AU130309UD	
	3P4W	3 Pole "C"	110	4	AU139404SA	AU130404SA	
			230	9	AU139409SA	AU130409SA	
			400	6	AU139406SA	AU130406SA	
			500	7	AU139407SA	AU130407SA	
	4P5W	3 Pole "C"	110	4	AU139504TA	AU130504TA	
			230	9	AU139509TA	AU130509TA	
			400	6	AU139TA	AU130TA	
	32*	3P4W	3 Pole "C"	380 50Hz 440 60Hz	3	AU139403SA	

* 32 Amp. Only for Refrigerated Containers.

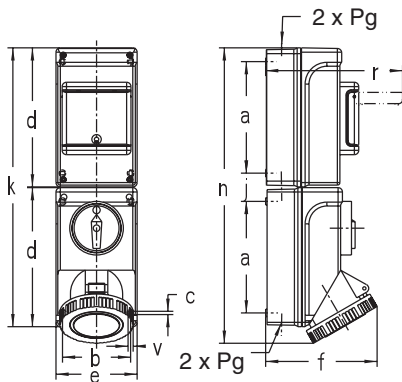

Drawing E

Dimensions

Amps	Poles and Wires	Unit of Measure	Dimensions													
			a	b	c	d	e	f	IP44	IP67	i	k	IP44	IP67	r	v
20	16	2P3W	inch	5.00	3.07	0.18	6.54	3.82	4.57	4.72	1.54	13.11	13.86	13.86	6.97	0.28
			mm	127	78	4.5	166	97	116	120	39	333	352	352	177	7
20	16	3P4W	inch	5.00	3.07	0.18	6.54	3.82	4.72	4.92	1.54	13.11	13.86	13.86	6.97	0.28
			mm	127	78	4.5	166	97	120	125	39	333	352	352	177	7
20	16	4P5W	inch	5.00	3.07	0.18	6.54	3.82	4.92	5.20	1.54	13.11	13.86	13.86	6.97	0.28
			mm	127	78	4.5	166	97	125	132	39	333	352	352	177	7
30	32	2P3W	inch	6.06	3.70	0.18	7.60	4.45	5.71	6.06	1.54	15.24	16.10	16.10	7.52	0.28
			mm	154	94	4.5	193	113	145	154	39	387	409	409	191	7
30	32	3P4W	inch	6.06	3.70	0.18	7.60	4.45	5.71	6.06	1.54	15.24	16.10	16.10	7.52	0.28
			mm	154	94	4.5	193	113	145	154	39	387	409	409	191	7
30	32	4P5W	inch	6.06	3.70	0.18	7.60	4.45	5.83	6.06	1.54	15.24	16.10	16.10	7.52	0.28
			mm	154	94	4.5	193	113	148	154	39	387	409	409	191	7



16, 32, 63, 125 Amp
Watertight (IP67)
Drawing B
(See Drawing on Page 49)



16, 32, 63, 125 Amp
Splashproof (IP44)
Drawing B
(See Drawing on Page 49)

Amps	Poles and Wires	Voltage AC	Clock Position of Ground Contact	NEMA 4X Watertight (IP67)	Splashproof (IP44)
16	2P3W	110	4	AJ119304SH	AJ110304SH
		230	6	AJ119306SH	AJ110306SH
		400	9	AJ119309SH	AJ110309SH
	3P4W	110	4	AJ119404SH	AJ110404SH
		230	9	AJ119409SH	AJ110409SH
		400	6	AJ119406SH	AJ110406SH
	4P5W	110	4	AJ119504SH	AJ110504SH
		230	9	AJ119509SH	AJ110509SH
		400	6	AJ1195SH	AJ1105SH
32	2P3W	110	4	AJ139304SH	AJ130304SH
		230	6	AJ139306SH	AJ130306SH
		400	9	AJ139309SH	AJ130309SH
	3P4W	110	4	AJ139404SH	AJ130404SH
		230	9	AJ139409SH	AJ130409SH
		400	6	AJ139406SH	AJ130406SH
	4P5W	110	4	AJ139504SH	AJ130504SH
		230	9	AJ139509SH	AJ130509SH
		400	6	AJ1395SH	AJ1305SH
32*	3P4W	380 50Hz 440 60Hz	3	AJ139403SH	
63	2P3W	110	4	AJ169304SH	AJ160304SH
		230	6	AJ169306SH	AJ160306SH
		400	9	AJ169309SH	AJ160309SH
	3P4W	110	4	AJ169404SH	AJ160404SH
		230	9	AJ169409SH	AJ160409SH
		400	6	AJ169406SH	AJ160406SH
	4P5W	110	4	AJ169504SH	AJ160504SH
		230	9	AJ169509SH	AJ160509SH
		400	6	AJ1695SH	AJ1605SH
125	2P3W	110	4	A0179304SH	
		230	6	A0179306SH	
		400	9	A0179309SH	
	3P4W	110	4	A0179404SH	
		230	9	A0179409SH	
		400	6	A0179406SH	
	4P5W	110	4	A0179504SH	
		230	9	A0179509SH	
		400	6	A01795SH	

* 32 Amp. Only for Refrigerated Containers.

PIN & SLEEVE DEVICES

Walther Pin & Sleeve Devices are manufactured to IEC 60309-1 & 2 standards and are interchangeable anywhere in the world with other manufacturers who conform to these IEC specifications: material, ground-pin location, size and color. Walther introduced and wrote the standard for the first IEC 60309 Pin & Sleeve Devices as they are known today. IEC 60309 devices are typically used to supply power for stationary or portable applications – i.e. electrically operated equipment: generator sets, compressors, welders, heating and cooling equipment, lighting or similar apparatus – anytime quick-safe connect/disconnect capabilities are required.

MECHANICAL INTERLOCK DEVICES

Walther IEC 60309 Mechanical Interlocks are designed to combine a disconnect switch and receptacle into one compact unit. The mechanical interlock receptacles are built for safety first by eliminating the possibility of making or breaking the circuit under load or by making a haphazard connection. Walther MIs cannot be energized, turned on, until completely plugged in and then they cannot be disconnected, plug removed, until the power is turned off. Units are available in Water-Tight IP67 (NEMA 4X) and Splash-Proof IP44 and MCB Breakered versions.

POWER DISTRIBUTION UNITS & SYSTEMS

Walther Electric offers unique, custom-built power distribution units and systems, integrating multiple variations of receptacles plus the installation of a power inlet that combined in a single unit is industry referred to and identified as a "Combination Outlet." Combination outlets combine multiple like receptacles or an assortment of various different receptacles in one compact enclosure. By integrating numerous receptacles into one electrical enclosure, multiple conduit runs with individual branch circuit wiring can be eliminated. As a result, installation and material costs are significantly reduced. Walther combination outlets are shipped completely wired and ready for use. In most applications only one connection to an incoming current supply and it is ready for use.

CUSTOM CABLE ASSEMBLIES

Walther's UL Custom Cable Assemblies are available in 6'/10'/25'/50' and 100' lengths. Other lengths are available via special quote. Walther IEC 60309 Plugs or Connectors are the most common termination devices used, but virtually every other type of NEMA device or CAM-style pins are also used. Plus custom splitter enclosure units are available.

PROCON HEAVY DUTY CONNECTORS: CAST ALUMINUM & PLASTIC

Walther Procon™ Heavy Duty Rectangular Connectors provide a safe, error free connection of multiple wire control and power circuitry from 4 to 216 pins. Devices require minimal installation space while providing maximum termination density for use in machine tools, robotics, material handling equipment, conveyers and for virtually all other types of electrical industrial machinery or electronic equipment. Devices replace the need for on-site hardwire installation requirements – simply mate the multi-pin inserts, snap on the cover hood and energize. Wash-down area units are available with an IP68 (Ingress Protection) rating.

Remote Access Interface Ports

Walther Remote-Access Interface Ports allow access to data and power from the outside of an enclosure – accomplished by installation of a panel-mount housing interface to the outside of a panel that contains a PLC or computer. The Walther Remote-Access Interface Ports allow users to interface the PLC or computer without opening the panel door thereby eliminating the potential safety hazards associated with an energized open electrical panel. Use eliminates the basic requirements of the mandated (NFPA-70E) need for arc-flash protective equipment and garments.

MANUAL DISCONNECT SWITCHES

Walther standard Manual Disconnect Switches combine a horsepower-rated switch in a tough, non-metallic NEMA 4X enclosure for safe surface-mount motor load disconnects. Several other models are available, including surface-mount Fused and Stainless Steel versions plus door-mounted rotary and toggle switch units. All models accept auxiliary contacts.

FITTINGS & ADAPTORS

Walther offers a complete-range of Fittings and Adaptors with NPT, Metric or PG threads. Units are available in Aluminum, Brass-Nickel Plated and Nylon. Products include Strain-Relief cord connectors with a range of 0.079" to 1.38", PG to NPT, Metric to NPT, PG to Metric and Metric to PG adaptors. All units meet or exceed UL, CSA and VDE specifications.

E-MOBILITY CHARGING PLUGS, RECEPTACLES AND EV CHARGING STATIONS

Walther is a worldwide leading manufacturer and supplier of E-Mobility (Electric Vehicle) charging plugs, receptacles and full-service EV Charging Stations. Nearly all industrialized nations, as well as a European-wide agreement, have already implemented the use of public charging stations or have established procedures to immediately advance E-Mobility especially in congested urban areas to help keep air clean and to help protect fossil fuel reserves. The future of the environment belongs to electric vehicles.

F. Walther Electric Corporation, Inc.
12F World's Fair Drive, Somerset, NJ 08873

(800) 925-8437 toll free | 800.925.8437 phone | (732) 537-9209 fax
custserv@waltherelectric.com | www.waltherelectric.com

